

STRATEGIC EUROPEAN DEPLOYMENT PLAN FOR THE EUROPEAN-WIDE IMPLEMENTATION OF THE TECHNICAL SPECIFICATION FOR INTEROPERABILITY TELEMATIC APPLICATIONS FOR FREIGHT (TAF TSI)



PROJECT No: 2005-EU-93008-S

Deliverable 3 – Overall TAF system development plan from-concept-to-delivery

PUBLIC





Table of Contents

| | |
|--|-----------|
| 1 Executive Summary | 1 |
| 2 Introduction | 2 |
| 2.1 Scope | 2 |
| 2.2 Methodology | 2 |
| 2.3 The Functional Requirements Specifications (FRS) | 2 |
| 3 Target TAF System Architecture Configurations | 4 |
| 3.1 Overview | 4 |
| 3.2 Core Architecture Components | 5 |
| 3.2.1 Wagon/ILU Trip Planning | 5 |
| 3.2.2 Wagon & Intermodal Operating Data WIMO | 6 |
| 3.2.3 Reference Files | 8 |
| 3.2.4 Infrastructure Restriction Notice Data (IRN) | 9 |
| 3.2.5 Common Interface | 11 |
| 3.3 On-line performance requirements: | 16 |
| 4 Rollout Plans | 17 |
| 4.1 SEDP Submissions | 17 |
| 4.1.1 Introduction | 17 |
| 4.1.2 Summary of Consolidated plan | 18 |
| 4.2 Existing International Systems | 26 |
| 4.2.1 Orfeus (ORF) | 26 |
| 4.2.2 International Service Reliability (ISR) | 30 |
| 4.2.3 Existing International IM Applications | 31 |
| 5 Risk Assessment..... | 44 |
| 6 Governance structure for the TAF TSI implementation | 45 |
| 6.1 Purposes of Governance..... | 45 |
| 6.2 Steering Committee & Railway Associations..... | 45 |
| 6.3 Monitoring and Policy | 47 |
| 6.4 Tasks of an Operations Organisation | 47 |
| 6.4.1 Administration | 47 |
| 6.4.2 Finance | 47 |



| | |
|---|-----------|
| 6.4.3 Management of outsourced IT functions | 48 |
| 6.4.4 Reference Data management | 49 |
| 7 Investment Estimation and Procurement strategies | 50 |
| 7.1 Investment Estimation | 50 |
| 7.2 TAF TSI Overall Performance Requirements | 50 |
| 7.2.1 Batch Performance requirements: | 50 |
| 7.3 Procurement Strategies | 50 |
| 7.3.1 Introduction | 50 |
| 7.3.2 Centralised procurements | 50 |
| 7.3.3 Shared Procurements | 51 |
| 7.3.4 Individual Procurements | 51 |
| Appendix A - Overview for Mandatory TAF TSI Components | 52 |
| Appendix B - Overview for Optional TAF TSI Components | 57 |



1 Executive Summary

This deliverable is the elaboration of an overall TAF system development plan from concept-to-delivery. What this document shows is that the great majority of the European rail freight industry has presented individual plans addressing the SEDP rollout. These plans have been synchronised and form a comprehensive Strategic European Deployment Plan for the TAF TSI.

It can be seen from the charts in section 4 that the European rail freight industry has collectively approved plans which will achieve the full implementation of TAF TSI functionality over the SEDP plan period – i.e. up to the end of 2013. This is a major achievement not only in synchronisation, but also in approach towards the improvement of the rail freight industry in Europe.

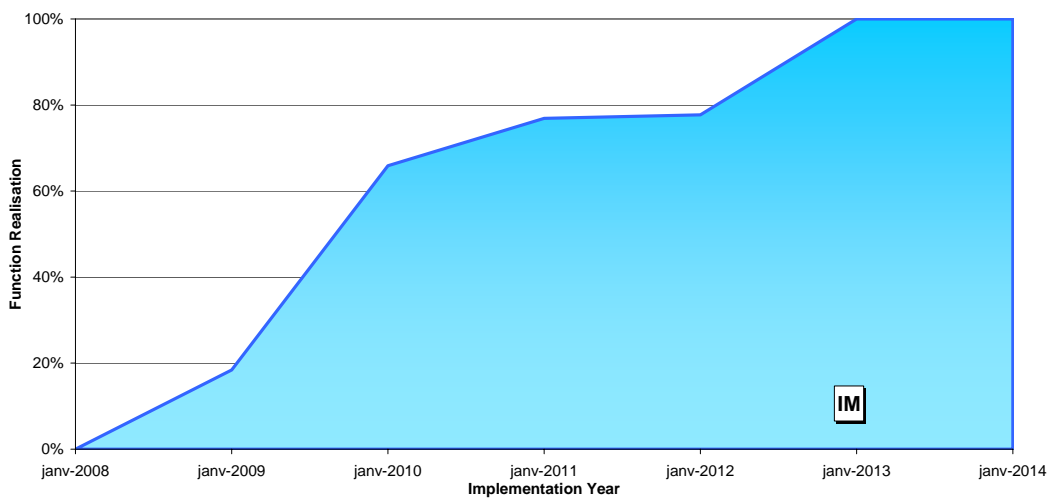

Figure 1 – Approved IM SEDP Functionality Rollout

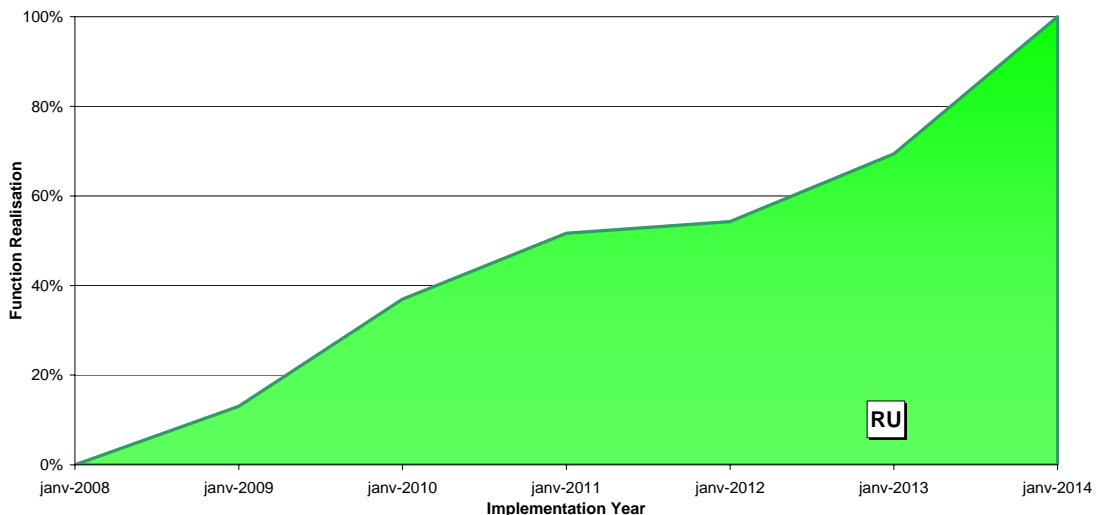

Figure 2 – Approved RU SEDP Functionality Rollout



2 Introduction

2.1 Scope

This deliverable provides guidelines on the process and the detail planning for the integration of legacy facilities as well as a risk assessment of the crucial phases of such a plan.

This document includes the identification of those major system and sub-system activities that are necessary to achieve the implementation of the TAF system, their aggregation within a set of project phases that is conducive to intermediate and verifiable tangible results within the context a detailed planning of the project phases for each actor in the European rail freight industry. The creation and synchronisation of this plan has been underpinned by an analysis of its major perceived risks – viz. business, financial, technical/operational - in order to ascertain its ultimate robustness. The industry's responses to the material risks are enclosed in the document.

Also included is the identification of the governance structure to allow the development of the TAF system and subsequently its field operation and management as well as the funding of the corresponding activities. The governance scenarios are appropriate for all RUs and IMs in the freight business and they will also be able to include intermodal operators, wagon owners and logistics companies. Recommendations on technical and organisational aspects of system operation and maintenance that can ensure the sustainability of revenue operations under acceptable levels of system availability and operational performance are included.

Potential procurement scenarios that might be put in place in order to reduce the time-to-revenue-service as well as the implementation costs are examined.

2.2 Methodology

This deliverable is based on individual stakeholder responses to the proposed Framework Plan (see Appendix A) as originally submitted to the industry at the beginning of the project. The Framework Plan was also supplemented with the Functional Requirements Specifications (SEDP Deliverable 2) so that the Stakeholders could properly assess the effort required for each SEDP Function and estimate the corresponding implementation dates.

Given the divergent capabilities of the European railway industry, a 'Cluster' approach was proposed in order to group stakeholders with like implementation priorities and timelines. This was a useful approach while the stakeholders were evaluating their individual SEDP plans. However, given the synchronised results of the responses, it became clear that a 'Cluster' approach to implementation was not necessary.

Additionally, only the mandatory elements of the TAF TSI were used in the evaluation and planning of the SEDP. The non-mandatory elements were removed from the evaluation template. A list of these mandatory elements is found in Appendix A.

2.3 The Functional Requirements Specifications (FRS)

The FRS documents provide implementation guidance for the content of the Regulation and represent a consensus view of necessary subcomponents. The set of documents produced in Deliverable 2 can be used as a basis for the technical Architecture during the implementation of the SEDP. The documents are as follows:

1. Specification 1 – Wagon/ILU Trip Planning.

Deliverable 3 – Public

PROJECT No: 2005-EU-93008-S



2. Specification 2 – Wagon & Intermodal Unit Operating Data
3. Specification 3 – Reference Files
4. Specification 4 – Infrastructure Restriction Notice Data
5. Specification 5 – Common Interface
6. Global Architecture Document (body of Deliverable 2)
7. TAF TSI Data & Message Model

These documents were produced in accordance with ISO and CEN Consensus procedures.



3 Target TAF System Architecture Configurations

The FRS documents in Deliverable 2 will provide the overall architectural framework for the SEDP. However, an alternate, decentralised architecture was chosen for the Database functions after the publication of the FRS documents.

The new requirements will be noted in this chapter rather than updating the prior deliverables. Some FRS documents will be revised during the TAF TSI deployment phase. The following FRS documents are affected by the revision in architecture (distributed databases) :

1. Specification 1 – Wagon/ILU Trip Planning.
2. Specification 2 – Wagon & Intermodal Unit Operating Data
3. Specification 3 – Reference Files (Keeper’s Rolling Stock Databases)
4. Global Architecture Document (body of Deliverable 2)

3.1 Overview

The Global Architecture describes how all the component functional parts fit together to meet the high-level requirements of the Regulation. It includes extensions to the key existing applications so that the SEDP may take advantage of current capabilities. The diagram below illustrates the common components and the required connectivity to the stakeholders’ systems.

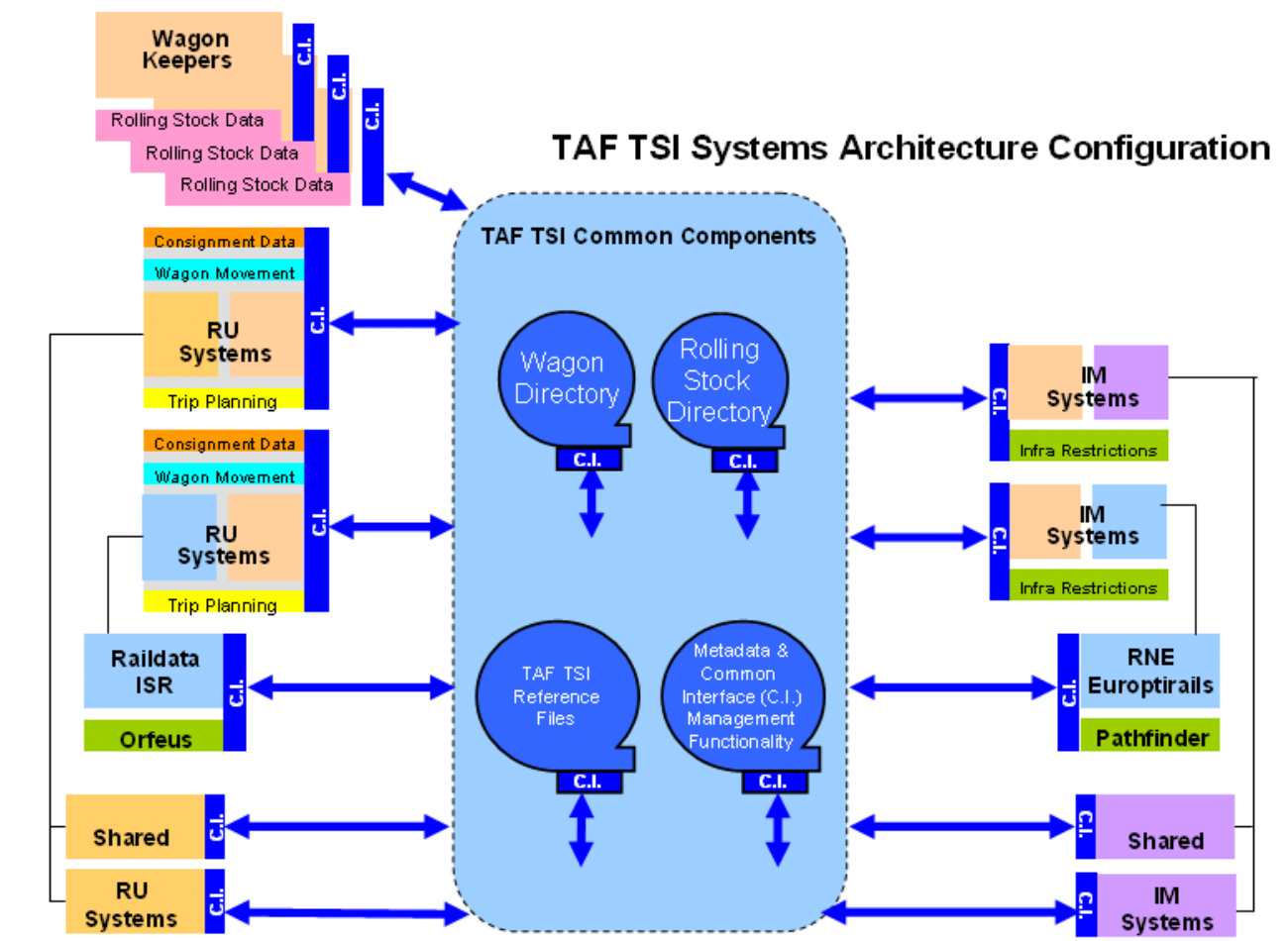



TAF System Deployment and Key Function Diagram

The following diagram illustrates the interaction of the system components. The reference files are used by all systems. The packages will use the Common Interface for interaction.

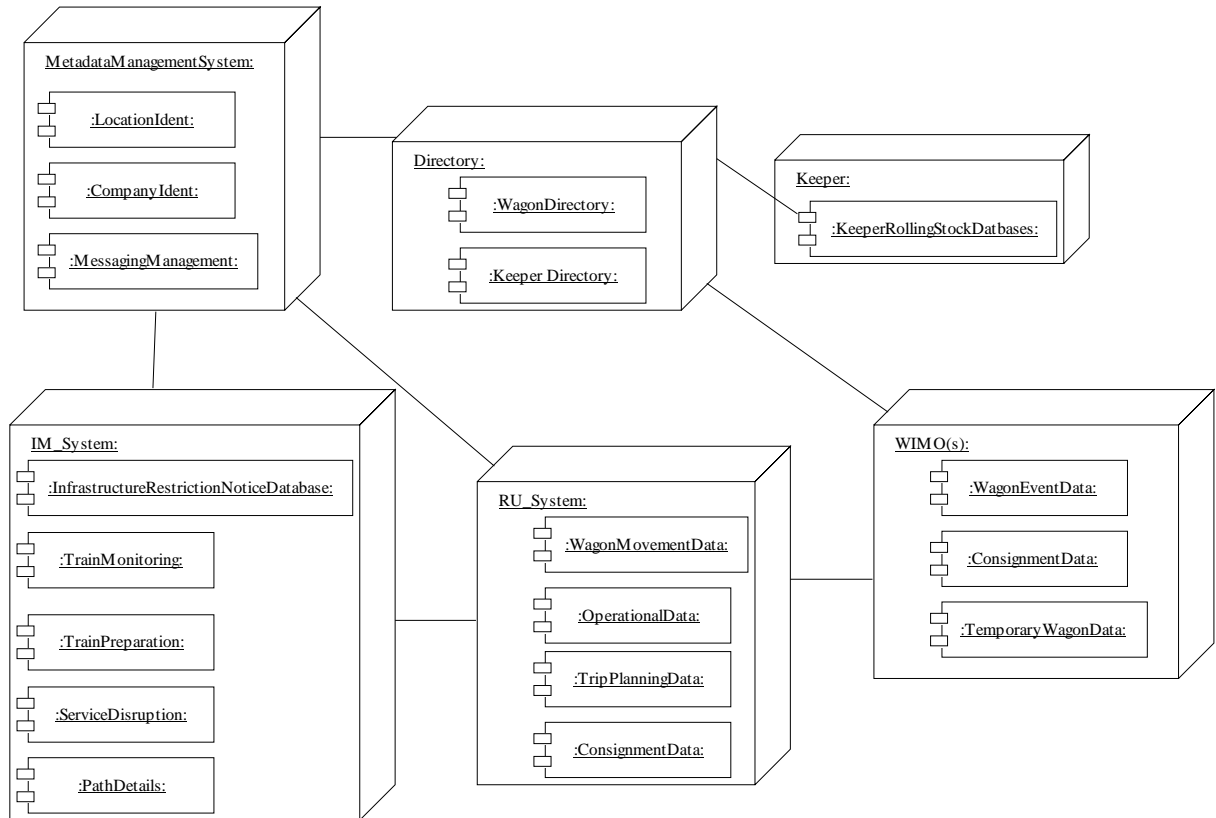

3.2 Core Architecture Components

3.2.1 Wagon/ILU Trip Planning

“International” Wagon Trip Planning

Showing TAF TSI Event References

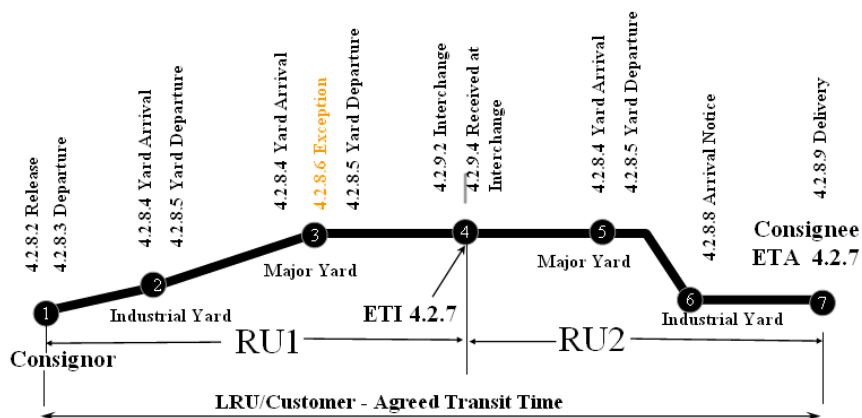



In 4.2.7 and 4.2.8.6 of the TAF TSI it is specified that RUs must have the capability of generating and sending current ETI and ETA messages for all wagons (Loaded & Empty, Local & Interline Service) and intermodal units. It also states that LRUs must be able to compare the ETAs with transit time commitments made to Customers.

The TAF TSI requires that ETAs are also sent to the LRU or Service Integrator who compares the ETA with what was promised to the customer. Alerts would be generated by the LRU as required for corrective action and Customer dialogues.

Note that the Trip Plans are internal to the RUs, including how they implement the functionality; only ETI and ETA messages are exchanged between RUs and used to update the individual WIMO Databases.

3.2.2 Wagon & Intermodal Operating Data WIMO

The TAF TSI obliges the installation of a Wagon and Intermodal Unit Movement Data Base (WIMO) for the freight services in the complete freight rail network of the member States of the European Union.

According to the requirements of the Steering Committee, the WIMO Database will not be a central Database, but each RU or groups of RUs will have their own individual WIMO Databases.

These WIMO Databases are the key databases for the tracking of wagons / Intermodal units and therefore for the communication between the RUs involved and the Lead RU / Service Integrator. These databases show the movement of a wagon and of an Intermodal unit from departure through to final delivery at customer sidings with ETIs and actual times at different locations until the final delivery time ETA.

In addition, the Rolling Stock operational Data (TAF TSI chapter 4.2.11.4) represent the actual status of the individual rolling stock for operational purposes. This data shall include temporary data, such as restrictions, current and projected maintenance actions, km, fault counters, etc.; and all data that could be considered as "status" (temporary speed restrictions, brake isolated, needs for repair and fault description, etc.).

To allow for the tracking of train and wagon movements, the WIMO Databases, updated at each relevant event in real time, are required. The WIMO Databases will be accessible via the Common Interface which must include a Wagon Directory or "Pointer" File in order to facilitate rapid responses to Tracking and Tracing inquiries. This approach does make some types of inquiries difficult such as "all wagons to one destination".

These databases are embedded in the global architecture via Common Interfaces.

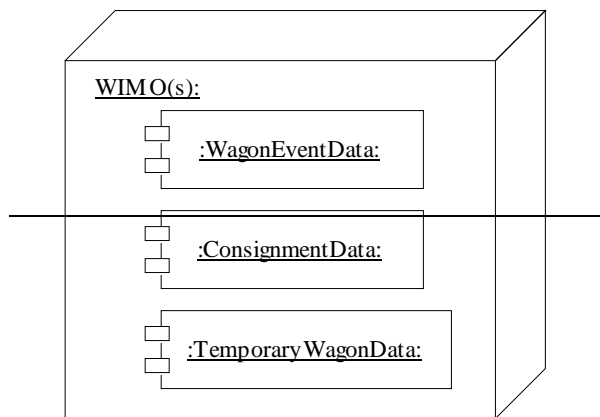

Data in the multiple WIMO Databases is classified into the following three sets:

- Entry level data
- Consignment level data
- Temporary wagon data

3.2.2.1 The Event Level data set

The Event Level data set consists of the RU related movement parts for the wagons and Intermodal units.

For the reporting of the movement of a wagon and the Intermodal units on it, the data of the following messages must be stored and electronically accessible. In addition they must also be sent on contractual bases to authorised parties.

- Wagon release notice
- Wagon departure notice
- Wagon yard arrival
- Wagon yard departure
- Wagon exceptions message
- Wagon interchange delivered
- Wagon interchange received
- Wagon arrival notice
- Wagon delivery notice
- Wagon delivery confirmation

3.2.2.2 The Consignment Level data set

The consignment note data are required to open a transport cycle within the system. The information will be taken from the Consignment Note Data and / or the Wagon Orders and is used to populate the records in the relevant WIMO Databases related to the wagon number. The information is given by the Lead RU. The LRU gets the data mainly from the transport order from the customer. In case of subcontracting RUs, the LRU sends specific message to them, where the data are specific on the role of the subcontracting RU (Origin RU, Transit RU Delivery RU). The WIMO Databases must take this into account for data access. Therefore this data set is important for the Authorisation concept and the Access Rights specification.

3.2.2.3 Temporary Wagon data



This data include temporary data, such as restrictions - and all data that could be considered as "status" related (temporary speed restrictions, brake isolated, needs for repair and fault description, etc.) (chapter 4.2.11.4).

The transport relevant technical data (static) for rolling stock stored in the individual keeper databases are accessible via the Keeper and Wagon Directories and stored in the common repository (chapter 4.2.14.6). This pointer file is updated based on the 'Wagon Received at Interchange' message, which must be sent by the relevant RU to the repository.

3.2.3 Reference Files

Normalised codes are needed to support data exchange as defined in the Technical Specification for Interoperability (TSI) relating to the subsystem Telematic Applications for Freight of the Trans-European Conventional Rail System referred to in Article 6(1) of Council Directive 2001/16/EC. To ensure data quality, the TSI for Telematic Applications for Freight (TAF) defines the need for centrally stored and administered reference files to be a repository for these codes. These codes and reference files ensure consistency of data interpretation across various application systems.

For the TAF-TSI system, two reference files are required to be centrally maintained and administered. The first is for Location Identification and the second for Company Identification (TAF-TSI Stakeholders). Both of these reference files will provide input into the metadata required by the Common Interface for correct validation, authentication and delivery of the TAF-TSI messaging.

For the centrally stored and administered Reference files, it is important that these files be consistent at all times. They must be accessible via the Common Interface by each RU and IM and updated in the most cost-efficient way as these files are not restricted to local or country related use.

3.2.3.1 LocationIdent Reference File

A location is a place, a geographic point, inside or outside the rail network, which is needed to be identified for operational, technical, administrative or statistical purposes. This can be either a Railway or a Customer location.

Locations can be Stations, Yards, Halts, Terminal or Transshipment Points, Loading Points, Marker Points, Warehouses, Maintenance Workshops, Traction Departments, Town Offices, Railway frontier-points, transit-points, hand-over points and interchange points, Customer Sidings. It can also represent a part or section of them.

The functional requirements for the LocationIdent Reference File may be found in Deliverable 2. However, the following provides a high-level outline of the required functionality as defined in the Deliverable.

3.2.3.1.1 Use of Enregistrement Normalisée des Etablissements Européennes (ENEE)

ENEE has been in use by the industry for over 20 years and has been integrated into many international and proprietary applications such as PATHFINDER, Europtirails and MERITS. The file provides Standard numerical codes that are compulsory for all exchanges of information between Railways and between RUs and third parties.

The Functional Requirements Specification defined for the TAF-TSI is based on the current ENEE and the corresponding coding structures as contained in the CEN Workshop Agreement for coding structures for LocationIdent.



ENEE may be used to fulfil the reference file requirements for Locations as it is already in use by the industry, notably in the Infrastructure domain. It is foreseen to expand the use of ENEE in common international applications in the coming years.

3.2.3.2 CompanyIdent Reference File

A Company identifies any actor in the transport chain, notably any Company, directly or indirectly involved in rail traffic or having a business relationship with one or more of such companies not being a customer. The definition of Company comprehends the following as defined in the TAF-TSI.

- IMPartner;
- NextResponsibleIM;
- NextResponsibleRU;
- Recipient;
- ResponsibleIM;
- ResponsibleRU,
- PreviousResponsibleRU;
- RUPartner;
- Sender.

The functional requirements for the CompanyIdent Reference File may be found in Deliverable 2. However, the following provides a high-level outline of the required functionality as defined in the Deliverable.

3.2.4 Infrastructure Restriction Notice Data (IRN)

Each IM is responsible for the suitability of a path on his infrastructure and the RU is obliged to check the train characteristics against the values given in the path details of its contracted path.

Without prejudice to the conditions for the usage of a path in the Network Statements or to the responsibilities in case of any restrictions in the infrastructure explained in the TSI Operation and Traffic Management, the RU must know before preparing the train, whether there are any restrictions on the line segments or stations (nodes) affecting its train composition described in the path contract.

For this the IMs must install and populate the Infrastructure Restriction Notice Databases. The structure of such a database is outlined in Deliverable 2. The entries in these databases are based on segments in line with the relevant Network Statements with the addition of restriction information. These databases must be accessible via the Common Interface.

The RU is obliged to take into account all restrictions in the Infrastructure Restriction Notice Databases affecting its train running until the pre-departure period. If nothing else is defined in a contract between the IM and RU, the pre-departure period starts one hour before the scheduled time of departure.”

In the pre-departure period the IM must notify directly the RU of any relevant changes arising in the Infrastructure Restriction Notice Databases.

It should be noted that the TAF-TSI does not require a centralised IRN. The Functional Requirements Specification in Deliverable 2 proposes a decentralised solution but allows also for shared solutions, for example Europtirails.

3.2.4.1 Adaptation in Europtirails

3.2.4.1.1 Functionality

The basic functionalities required by the IRN DB are currently realised by Europtirails, however some adaptations would be necessary.



3.2.4.1.2 Common Interface

As the IRN Databases must be accessible via the Common Interface, Europtirails must also be accessible in the same manner. Europtirails should also cover other TAF-TSI Functions which require the Common Interface, therefore it is not a specific requirement of the IRN DB.

3.2.4.1.3 RU connection

The IRN Databases must be accessible to the Railway Undertakings. This means that Europtirails must be accessible to the Railway Undertakings as well. Europtirails should also cover other TAF-TSI Functions which require connection to the Railway Undertakings, therefore it is not a specific requirement of the IRN DB.

3.2.4.1.4 Geographical Scope

The current approach of Europtirails is Corridor based. That means that only a part of the network is covered by Europtirails. The IRN requires that the whole network used by freight trains is included in Europtirails.

3.2.4.1.5 Geographical density

Europtirails includes only points every 10 to 30 km. This may not be detailed enough for the needs of the IRN. Additional points may be required to meet the needs of the IRN

3.2.4.1.6 Participating IMs

Six IMs participate in the first phase of Europtirails. Other will join when the operation of Europtirails is transferred to Rail Net Europe. It is not clear if all European IMs will join Europtirails. Those not joining Europtirails would have to develop their own Databases.

3.2.4.1.7 Filtering

Filtering (based on allowed routes, on train identifications, or on any IM specific criteria) is optional according to the IRN FRS. It could be included in Europtirails.

3.2.4.1.8 Automatic sending by IM

The IMs may either send the information manually or automatically. Right now all IMs send the information manually.

3.2.4.1.9 Phasing

All steps do not have to be implemented immediately. A possible phasing could be the following:

1. Common interface
2. RU connection
3. Geographical Scope
4. Geographical Density
5. Extension of participating IM
6. Filtering Functionalities
7. Automatic sending



3.2.5 Common Interface

In relation to the Common Interface, the Telematics Application for Freight Services Sub System (TAF TSI) documents the essential requirements for Telematics Applications (referring to 2.7.1 and 2.7.2 of Annex III to Directive 2001/16/EC):

The essential requirements for Telematic Applications guarantee a minimum quality of service for passengers and carriers of goods, particularly in terms of technical compatibility. Steps must be taken to ensure:

- that the databases, software and data communication protocols are developed in a manner allowing maximum data interchange between different applications and operators, excluding confidential commercial data;
- easy access to the information for users.

The methods of use, management, updating and maintenance of these databases, software and data communication protocols must guarantee the efficiency of these systems and the quality of the service.

Consequently, chapter 4.2.14.7 of the TAF TSI document states that the Common Interface is mandatory for each actor in order to join the TAF TSI rail interoperability community and must have the following capabilities:

- message formatting of outgoing messages according to the metadata,
- signing and encryption of outgoing messages,
- addressing of the outgoing messages,
- authenticity verification of the incoming messages,
- decryption of incoming messages,
- conformity checks of incoming messages according to metadata,
- handling the single common access to various databases.

3.2.5.1 Multiple WIMOs and Rolling Stock Databases

Functionality to enquire on the Wagon and Rolling Stock directories and to direct the enquiry to the correct database is required in the Common Interface to deal with multiple WIMO and Rolling stock databases as follows:

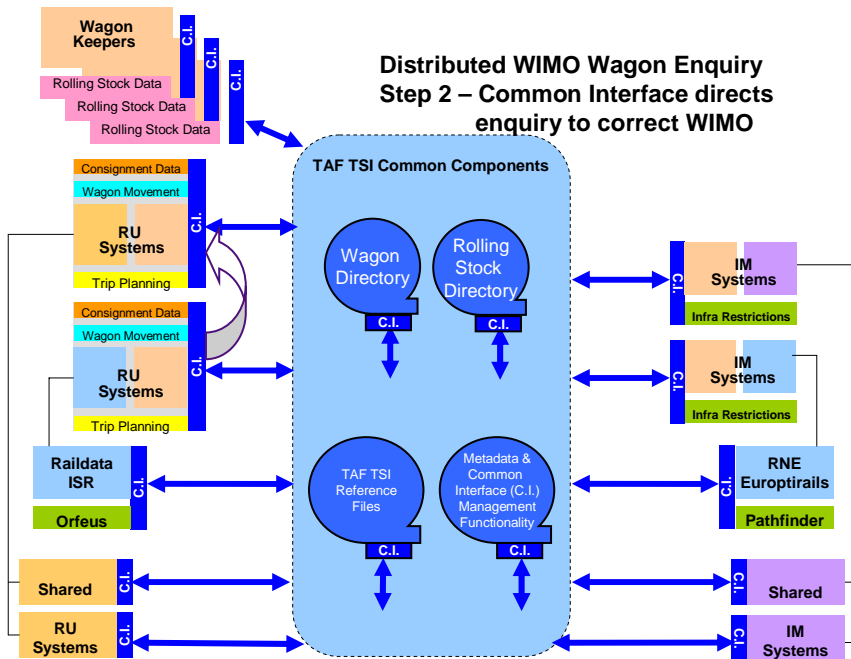
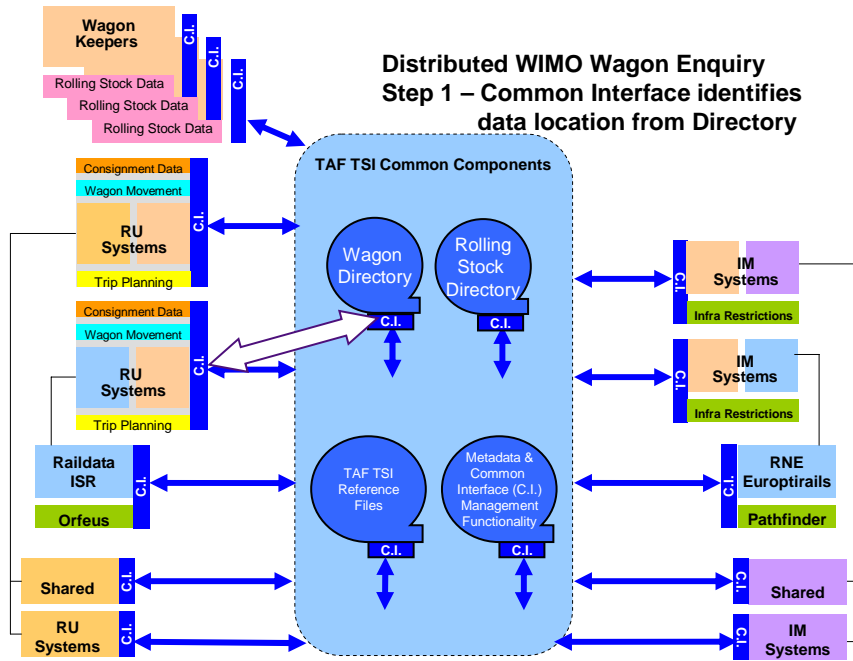

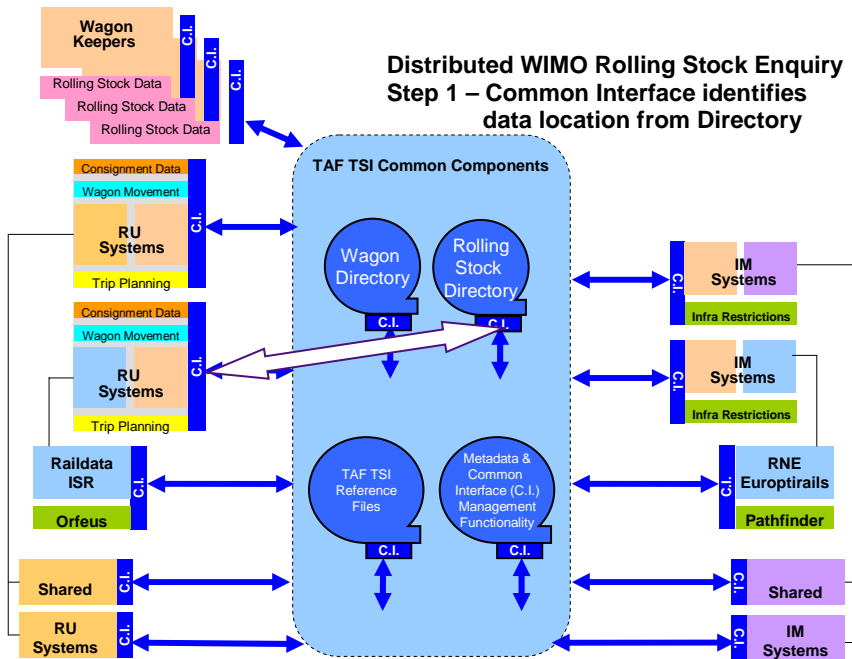
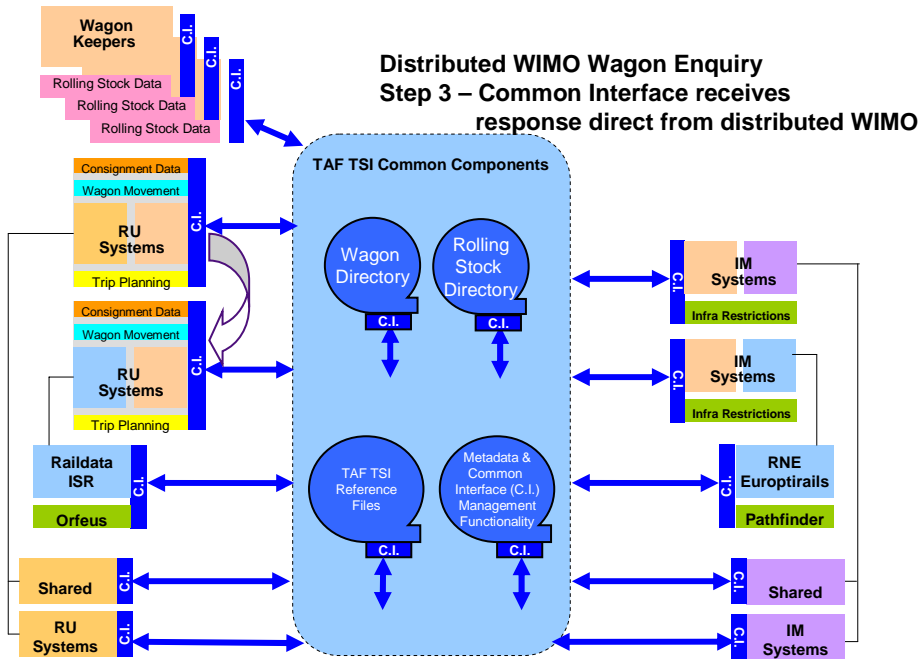

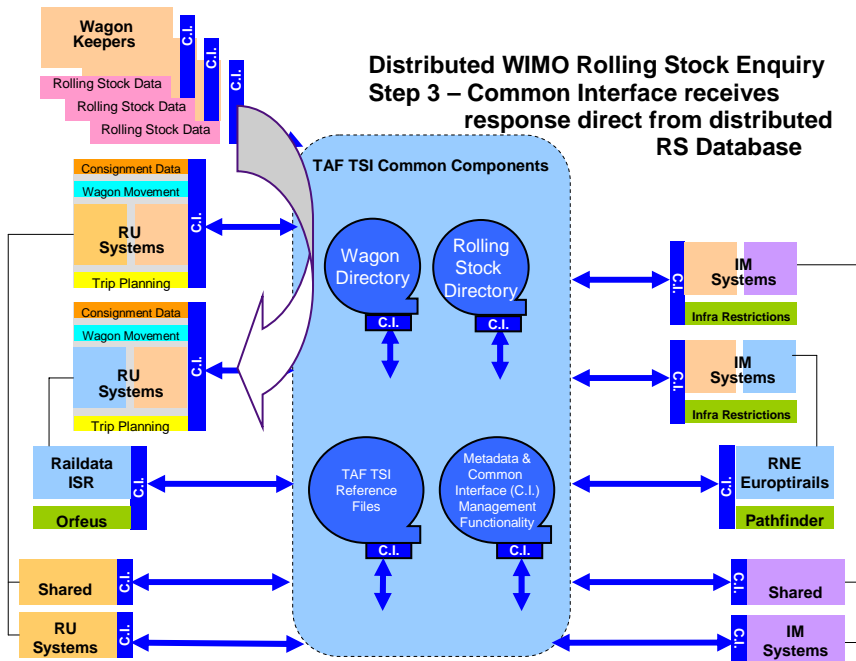
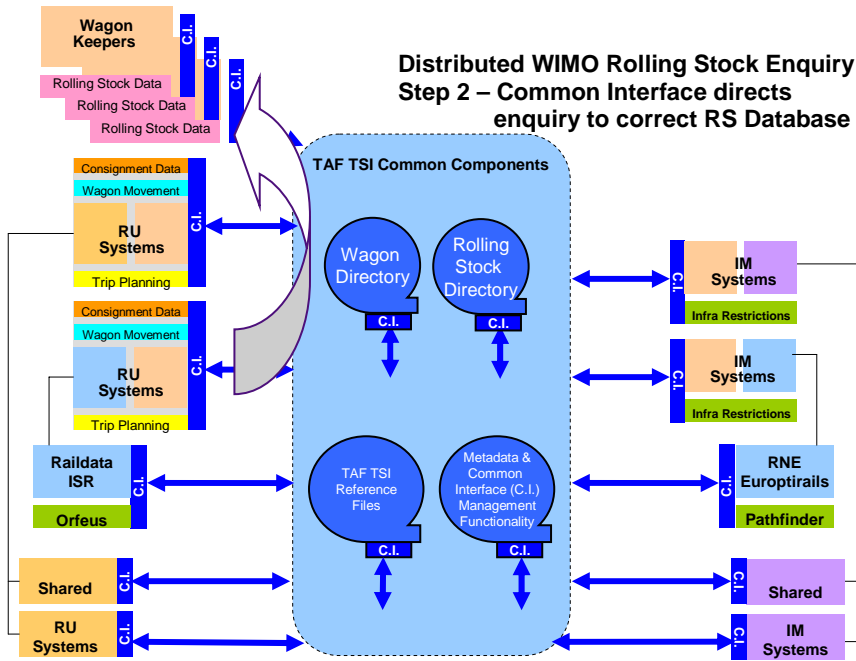



3.2.5.2 Translation and Validation Layer

The Translation and Validation layer of the Common Interface receives data from and sends data to the API layer on the one side and receives from and presents TAF TSI messages to the Security and Transport layer of the Common Interface utilising the Common Interface Metadata for its translation and validation rules. Below is a table of existing messages that may be transformed into a TAF-TSI compliant message in order to ease the burden of implementation.

| Existing Message | Description | TAF TSI TSI message(s) |
|------------------|--|---|
| CTD-ORFEUS | Consignment note completed/ created | 4.2.1.2. Wagon Order (subset of CN) |
| UTD-ORFEUS | Consignment note modified | 4.2.1.2. Wagon Order |
| UTD-ORFEUS | Transport cancelled | |
| IFTSTA/ XML | Wagon can be pulled from customer | 4.2.8.2. Wagon Release Notice |
| IFTSTA/ XML | Wagon pulled from customer | 4.2.8.3. Wagon Departure Notice |
| IFTSTA/ XML | Wagon left departure place/station | |
| IFTSTA/ XML | Wagon has arrived at yard | 4.2.8.4. Wagon Yard Arrival |
| IFTSTA/ XML | Wagon has departed from yard | 4.2.8.5. Wagon Yard Departure |
| IFTSTA/ XML | Wagon is going to cross borders | 4.2.9.2. Wagon Interchange Notice |
| IFTSTA/ XML | Wagon crossed borders - unspecified | 4.2.9.3. Wagon Interchange Notice / Sub |
| IFTSTA/ XML | Wagon crossed borders –exit | 4.2.9.3. Wagon Interchange Notice / Sub |
| IFTSTA/ XML | Wagon crossed borders -entry | 4.2.9.3. Wagon Interchange Notice / Sub |
| IFTSTA/ XML | Wagon is out of service Wagon is repaired | 4.2.8.6. Wagon Exception |
| IFTSTA/ XML | Wagon arrived to destination station | 4.2.8.8. Wagon Arrival Notice |
| IFTSTA/ XML | Wagon delivered to customer | 4.2.8.9. Wagon Delivery notice |
| UIC 407-1 2001 | Train Running Forecast | 4.2.4.2 Train Running Forecast |
| UIC 407-1 2002 | Train Running Information | 4.2.4.3 Train Running Information |
| | Train Running Interruption | 4.2.5.2 Train Running Interruption |
| UIC 407-1 2090 | Path Request | 4.2.2.2 Path Request |
| Europtirails | Path Details | 4.2.2.3 Path Details |

Deliverable 3 – Public

PROJECT No: 2005-EU-93008-S



| | | |
|--|----------------------------|-----------------------------------|
| UIC 407-1 2003 | Train Delay Performance | 4.2.6.3 Train Delay Performance |
| UIC 407-1 Generic 2004 /2201 & Europtirails 2004 | Train Composition | 4.2.3.2 Train Composition |
| UIC 407-1 2701 | Train Running Interruption | 4.2.5.2 Train Running Interrupted |

It is expected that translation from existing messages as per the above table will be fully implemented by January 2010, noting that not all TAF TSI mandatory data may be supplied from the existing messages shown above. It is further expected that implementation of all remaining mandatory elements of TAF TSI messages which are themselves derived from the existing messages shown above, will be achieved by Jan 2011.

The public metadata will hold the TAF-TSI XML Schema shown in the Common Interface XSD, allowing internal systems to process correctly formatted TAF TSI messages into and out of the Queues without Translation.

3.3 On-line performance requirements:

A single instance of a Common Interface should be capable of communicating with up to 10000 other Common Interface instances and communicating simultaneously with up to 30 internal applications.

Each Common Interface instance must be capable of sending/receiving:

- nominal stress: a sustained rate of up to 30 TSI TAF messages/database accesses (any mix) per second;
- peak stress: a 1 minute peak of up to 50 TSI TAF messages/database accesses (any mix) per second.

All TAF TSI messages should be delivered (i.e. Common Interface – internet – Common Interface) in less than 2000 ms, and 90% should be within 500 ms.

The expected average transaction volume to WIMO databases across Europe is 2.9m per day. Storage space, internal communication throughputs, licences, processing power (event timescales) and internal system architecture for each WIMO should allow for the relevant share of this volume so that 90% of WIMO enquiries can be processed within 1 second and 100% within 2 seconds, thus giving an average response time for WIMO enquiries from one RU to another and back of 2 seconds and a maximum of 6 seconds.

The end-to-end TAF TSI should be available 99.9% measured on a monthly basis (maximum total outage 525 minutes/year) with a maximum number of unplanned outages per year of 50 (MTBF=1 week).

Other specific performance elements are shown in Deliverable 2.



4 Rollout Plans

As can be seen clearly in this section, the great majority of the European rail freight industry has presented individual plans addressing the SEDP rollout developed during the Framework Plan stage of the SEDP project. These plans have been synchronised and are presented in this section in a form that will be used in Deliverable 5 to constitute the ‘public’ Strategic European Deployment Plan for the TAF TSI.

It can be seen from the charts that the European Rail Freight Industry has collectively approved plans which will achieve the full implementation of TAF TSI functionality over the SEDP plan period – i.e. up to the end of 2012. This is a major achievement not only in synchronisation, but also in approach towards the improvement of the rail freight industry in Europe.

Approved plans from Freight Railway Undertakings
 representing > 80% of tonne-km



Approved plans from Infrastructure Managers
 representing > 80% of track-km

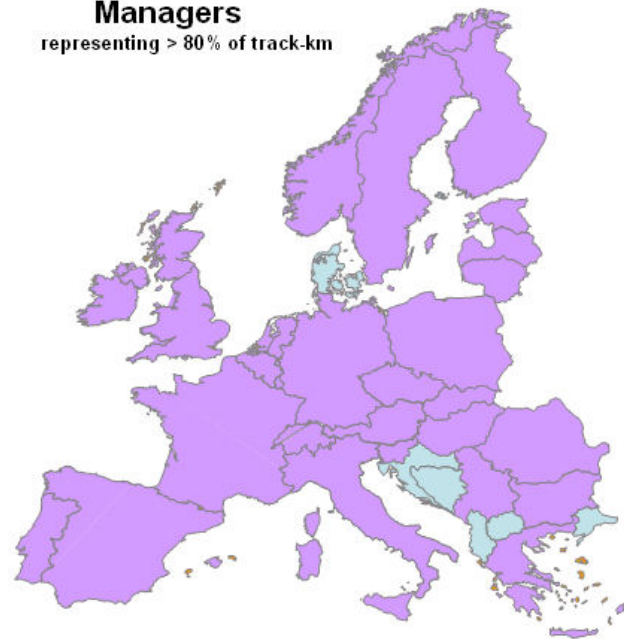

Responses have been received from the following companies and are included in the appendices:

| Type | Company | Appendix |
|-------|-----------------|------------------------------|
| IM | ADIF | C1 |
| RU | Astoc | C2 |
| IM | Banverket | C3 |
| RU | B-Cargo | C4 |
| RU | BLS Cargo | C5 |
| RU | BDZ | C6 |
| IM | NRIC (Bulgaria) | C7 |
| IM+RU | CD | C8 |
| IM+RU | CER (Hungary) | C9 |
| IM+RU | CFL | C10 |
| | CFR | |
| IM | Infrastructure | C11 |
| RU | CFR Marfa | C12 |
| RU | CP | C13 |
| IM+RU | DB Holding | C14 (incl. DB-Netz, Railion) |



Germany, - Denmark, -
Netherland, - Italy, MEG and
RAG)

| | | | |
|-------|-----------------|-----|-----------------------|
| IM+RU | EVR | C15 | |
| RU | EWS | C16 | |
| RU | Green Cargo | C17 | |
| IM+RU | Gysev | C18 | |
| IM | Infrabel | C19 | |
| IM+RU | Irish Rail | C20 | |
| IM+RU | LDZ | C21 | |
| IM | JBV (Norway) | C22 | |
| IM+RU | Litrail | C23 | |
| RU | MAV Cargo | C24 | |
| IM | MAV IM | C25 | |
| IM | Network Rail | C26 | |
| IM | ÖBB infra | C27 | (incl. ÖBB – Betrieb) |
| IM+RU | OSE | C28 | |
| RU | PKP Cargo | C29 | |
| IM | ProRail | C30 | |
| IM+RU | Rail Polska | C31 | |
| RU | RCA | C32 | |
| RU | Renfe | C33 | |
| IM | RFF | C34 | (incl. SNCF Infra) |
| IM | RFI | C35 | |
| IM | RHK | C36 | |
| RU | SBB Cargo | C37 | |
| IM | SBB infra | C38 | |
| IM+RU | Serbian Railway | C39 | |
| IM+RU | SZ (Slovenia) | C40 | |
| RU | SNCF Fret | C41 | |
| RU | Trenitalia | C42 | |
| RU | Veolia | C43 | |
| RU | VR | C44 | |
| RU | ZRS | C45 | |
| IM | ZSR | C46 | |
| RU | ZSSR | C47 | |
| IM | REFER | C48 | |

4.1.2 Summary of Consolidated plan

This section provides the aggregate plan responses by function. Each function is weighted according to the realisation effort as supported by the ECORYS cost study done for the TAF-TSI. The consolidated planning shows that the TAF-TSI will be implemented by 2013. Due to the differences in effort between the IM and RU functions, the two groups are shown in different graphs.

Most of the responses by function show a coherent and rapid implementation timeline, while other, higher-risk functions show a more gradual implementation timeline in order to reduce the overall risk for a successful implementation. The coherent functions (rapid deployment) can be marked as milestones, as each of them is put in place as building blocks for subsequent functions. The end result shows a harmonised SEDP with risks evenly spread across the industry by function.



The graphs below illustrate the overall realisation planning by IM and RU responses.

4.1.2.1.1 Infrastructure realisation

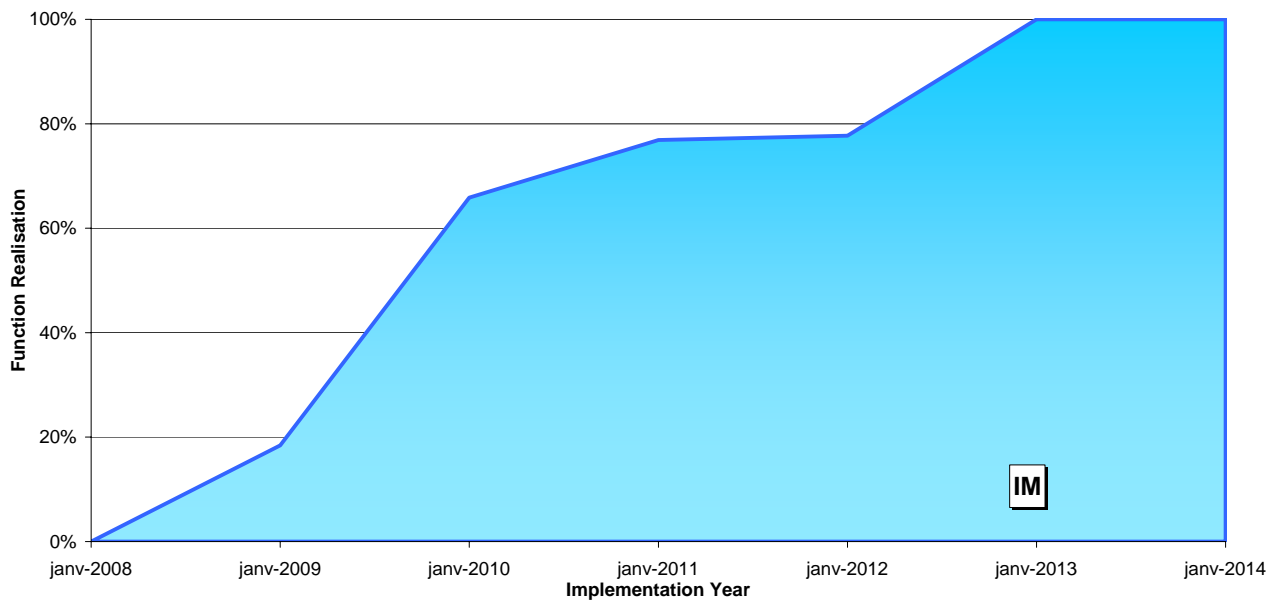

4.1.2.1.2 Railway Undertaking realisation

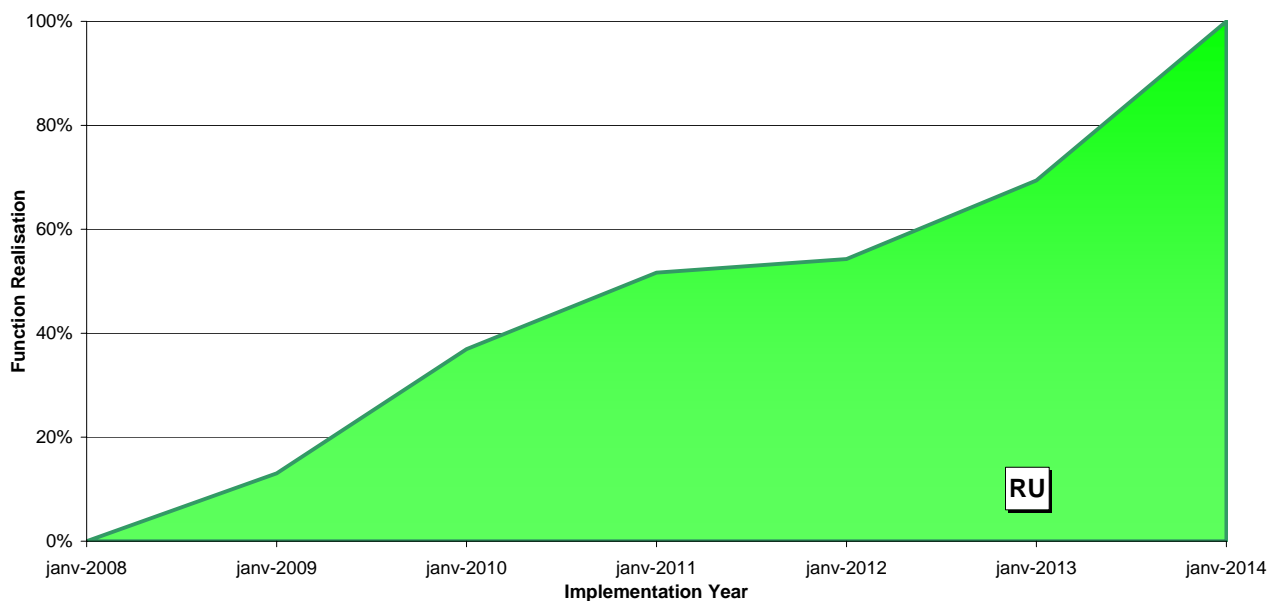

4.1.2.2 Realisation of the IM – RU Functions

These functions are jointly realised by both Infrastructure Managers and Railway Undertakings.

4.1.2.2.1 Realisation of the Common Interface Function (Milestone)

The Common Interface function must be realised by both IMs and RUs and represents the first milestone for the SEDP. The Common Interface provides the ability for all stakeholders



to exchange information, and must be put into place prior to the realisation of any other function. This is a common priority with a rapid deployment timeline.

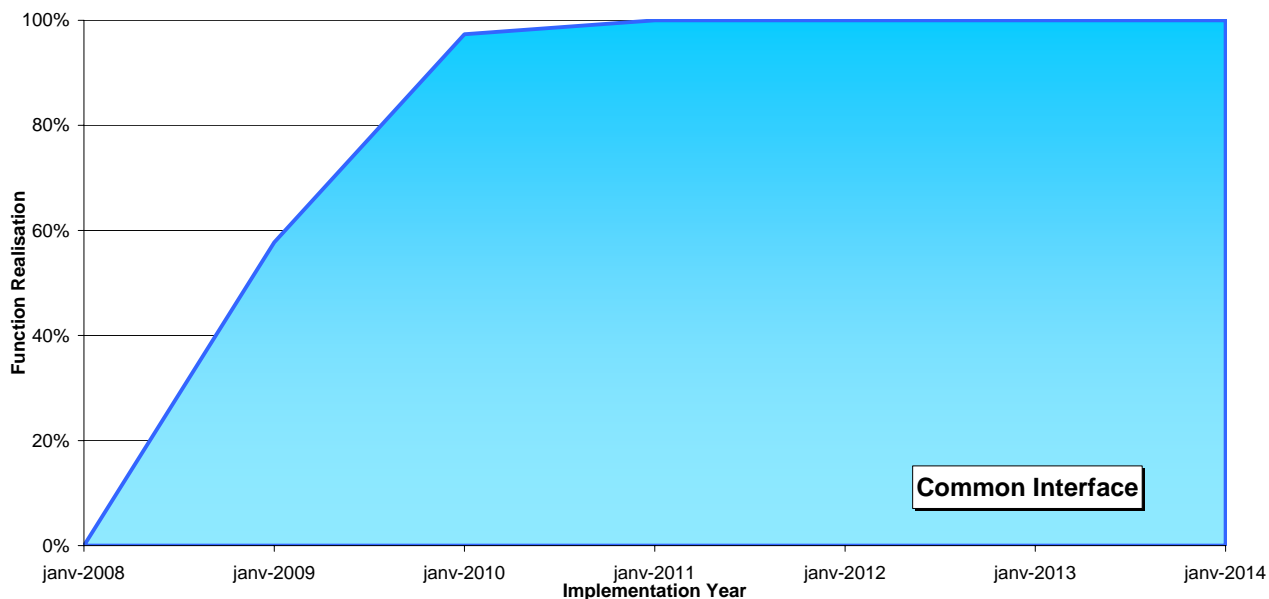

4.1.2.2 Realisation of the Reference File Function (Milestone)

Much like the Common Interface, the Reference Files for LocationIdent and PartnerIdent provide the necessary building blocks for quality data exchange. This is also a common priority for both IMs and RUs and should be the Second Milestone.

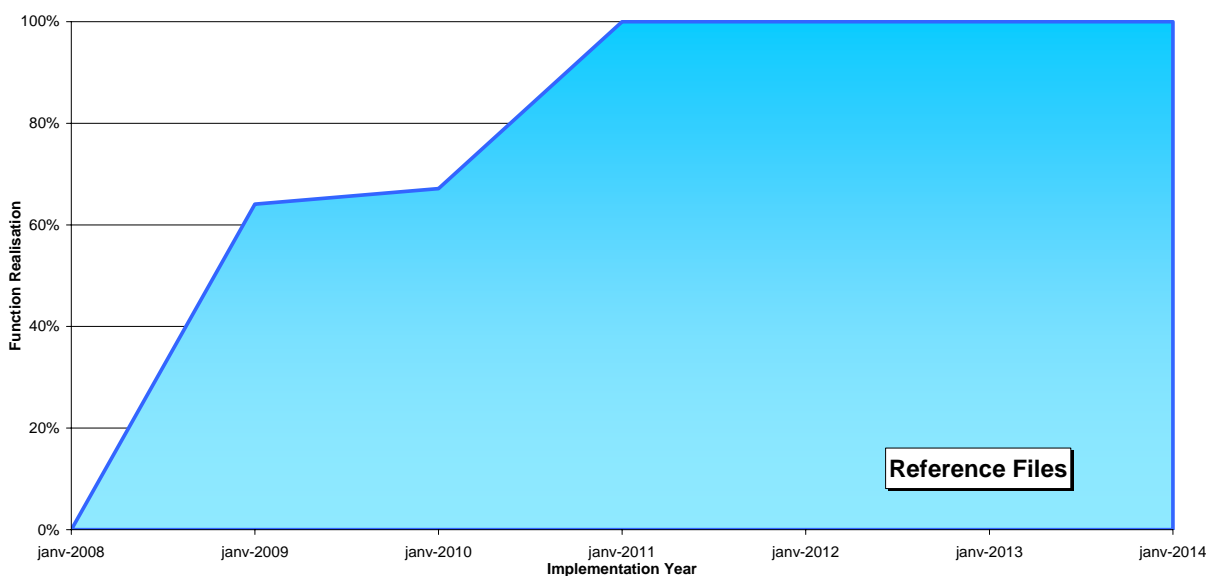

4.1.2.2.3 Realisation of the Train Running Information Function

The Train Running Information Function is a push message coming from the IM to the RU. This function is either already existing in a majority of the IM systems or can be realised fairly quickly. The RU risk is decreased by spreading the deployment of this functionality over a longer period of time. However, over 60% of the industry will be prepared to utilise this function by 2010.

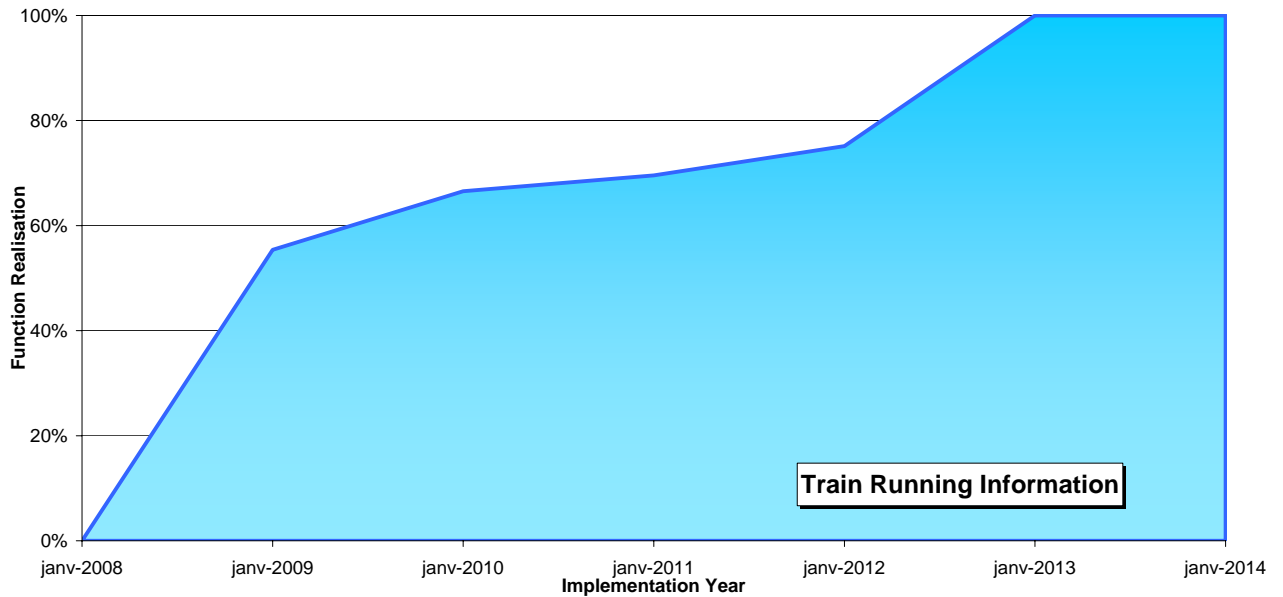

4.1.2.2.4 Realisation of the Train Forecast Function

The Train Forecast Function is a push message coming from the IM to the RU. This function is either already existing in a majority of the IM systems or can be realised fairly quickly. The RU risk is decreased by spreading the deployment of this functionality over a longer period of time. However, almost 70% of the industry will be prepared to utilise this function by 2010.

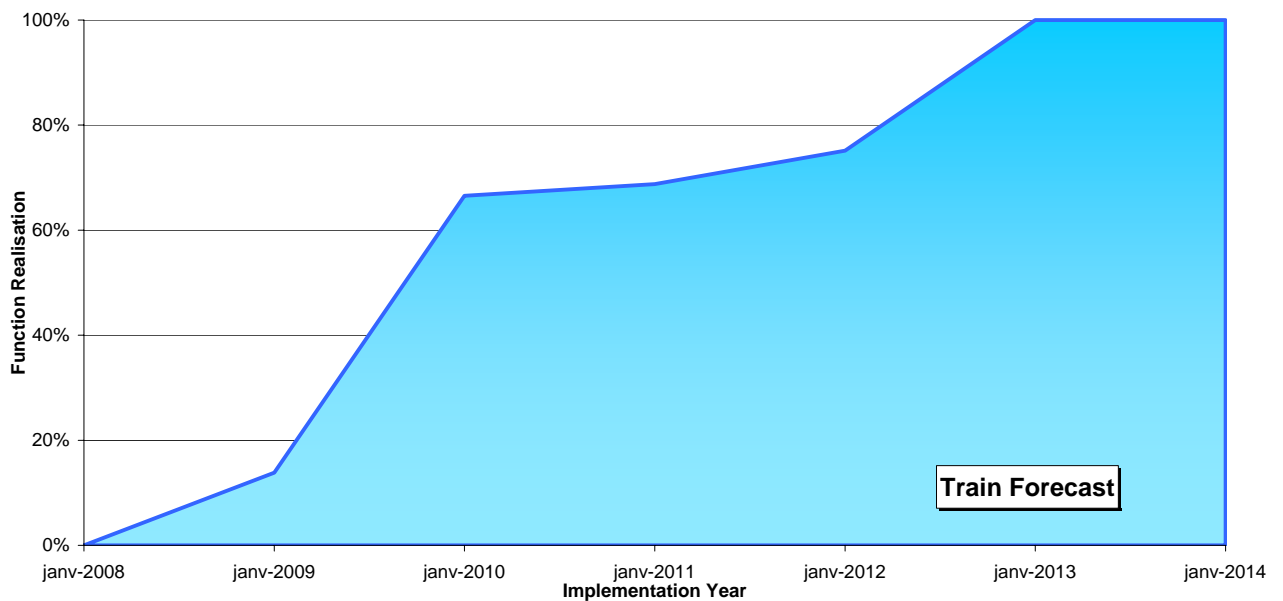

4.1.2.2.5 Realisation of the Service Disruption Function

The Service Disruption Function is a push message coming from the IM to the RU. This function is either already existing in a majority of the IM systems or can be realised fairly quickly. The RU risk is decreased by spreading the deployment of this functionality over a longer period of time. However, over 60% of the industry will be prepared to utilise this function by 2010.

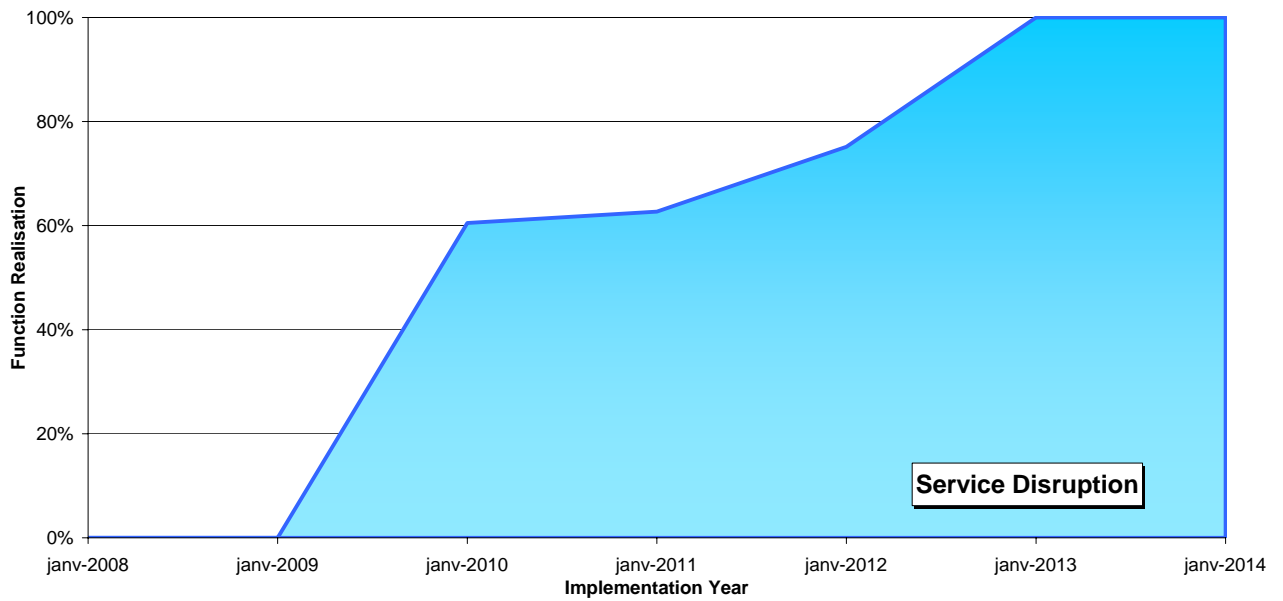

4.1.2.2.6 Realisation of the Train Enquiries Function

The Train Enquiries Function is an interactive application for message exchange between the IM to the RU. This function has a rapid deployment, illustrating the overall effort required on the parts of both the IMs and RUs. The Train Running and Forecast Functions must be in place prior to the final realisation of this function. Over 60% of the industry will be prepared to utilise this function by 2011.

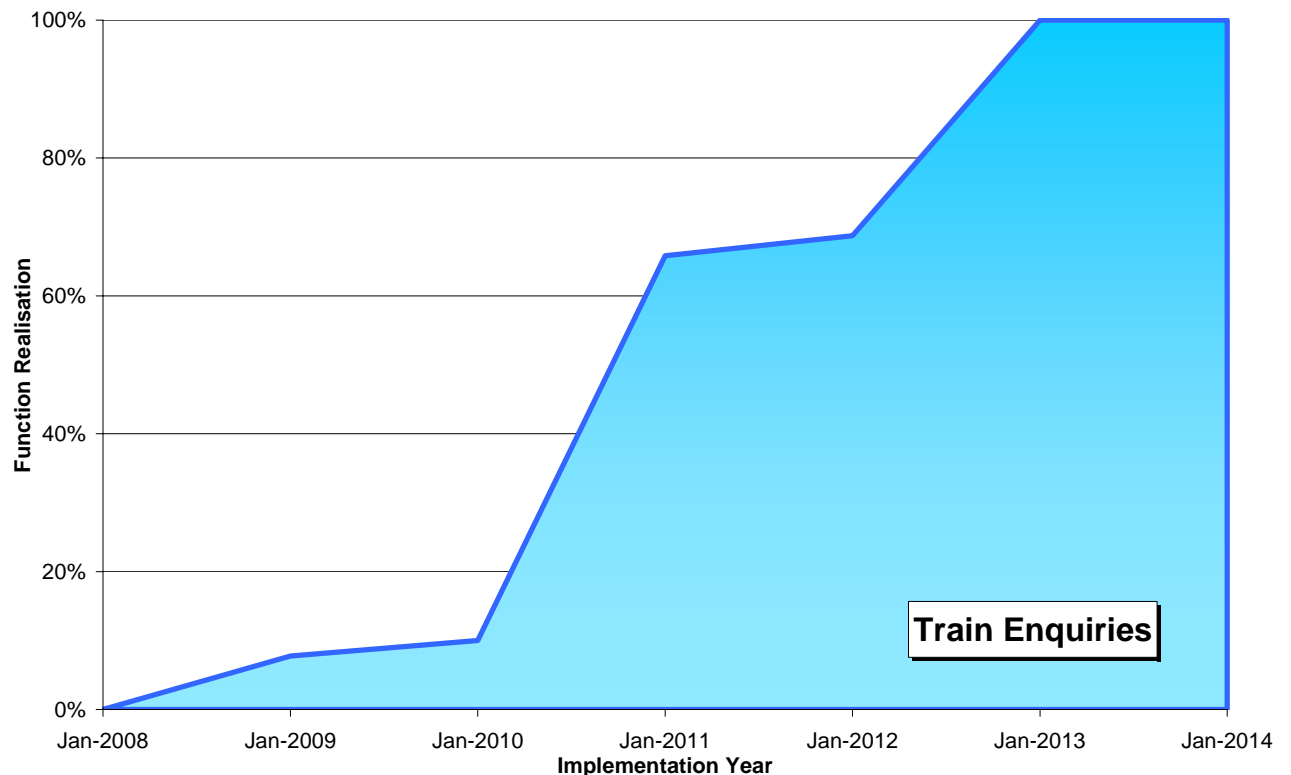



Realisation of the Train Preparation Function

The Train Preparation Function comprises the data exchange between IMs and RUs. This function relies on the realisation of prior functions such as the Common Interface, Reference Files and Rolling Stock. This is why there is a rapid realisation starting in 2009.

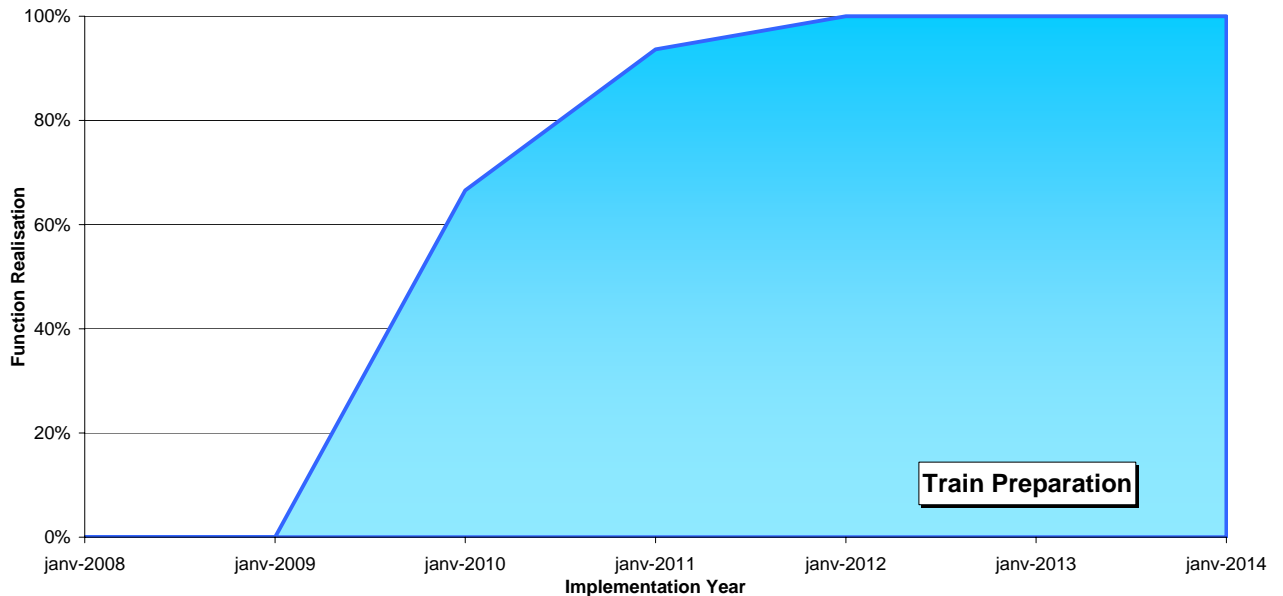

4.1.2.2.7 Realisation of the Infrastructure Restriction Notice Function

The Infrastructure Restriction Notice Function is realised only by the IMs, however the databases and information is made available to the RUs. Although there is a rapid early deployment, given the priority of this function, it is recommended that this realisation be moved back to the end of the SEDP. This may allow a more gradual implementation, allowing more coordination between the IMs and the RU users. Such a gradual implementation will reduce the overall risks to the industry.

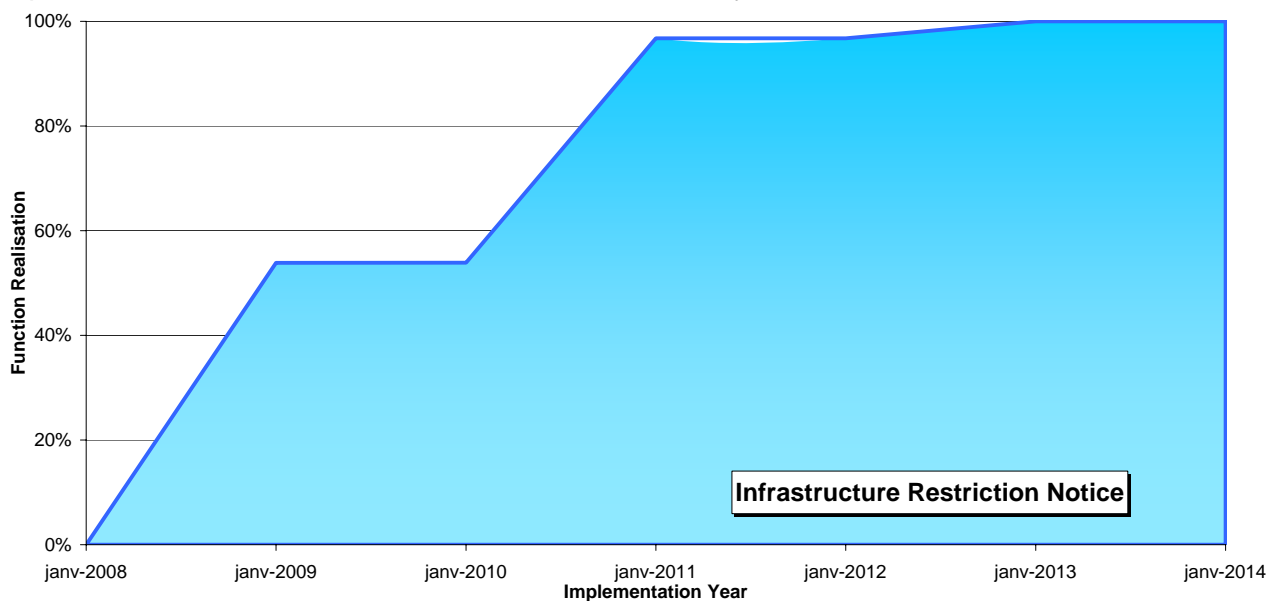

4.1.2.2.8 Realisation of the Path Request Function

The Path Request Function as defined in the TAF-TSI is to accommodate short-term path requests outside of the long-term planning phase. This is a priority function for both the IMs and the RUs, although it will require profound process and IT system modifications. This



function can be split into two distinct areas: 1) The realisation effort on the part of the RUs to organise the international path request and 2) the effort to coordinate and deliver a short-term path amongst the involved IMs. The realisation graph as shown below illustrates the RU community realisation plans early, with a synchronised rapid deployment by the IM and RU communities starting in 2012.

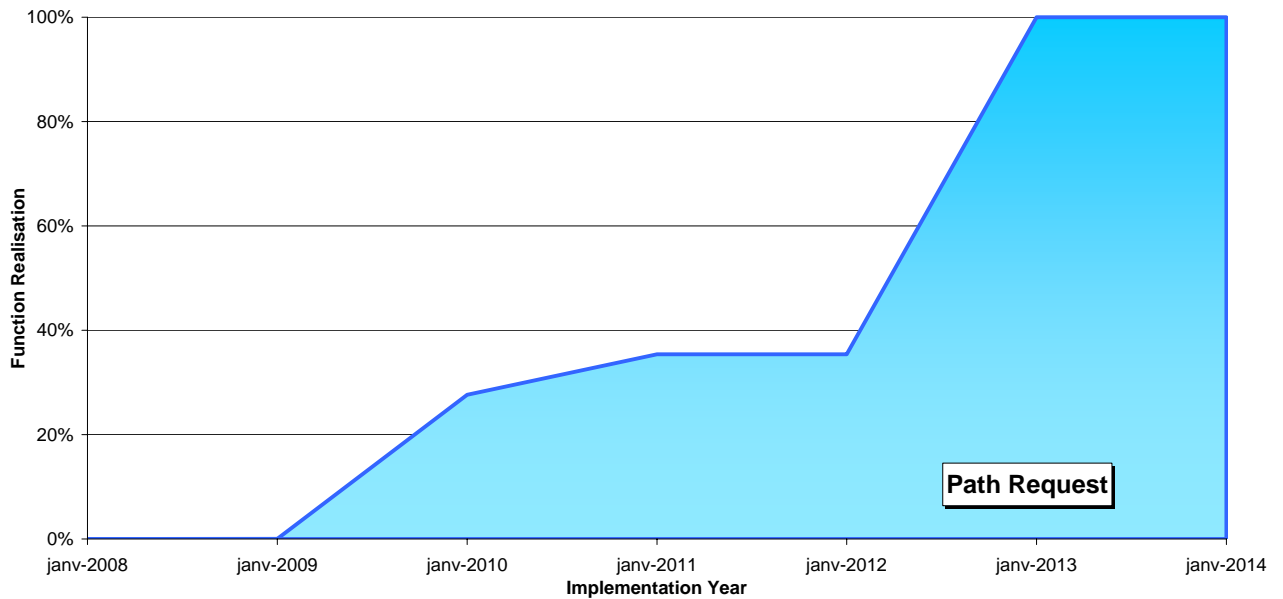

4.1.2.3 Realisation of the RU Functions

The following functions are realised only the RU community.

4.1.2.3.1 Realisation of the Consignment Data Function (Milestone)

Many RUs have existing capabilities to meet the requirements of this function, explaining the coherent deployment timeline between 2010 and 2011.

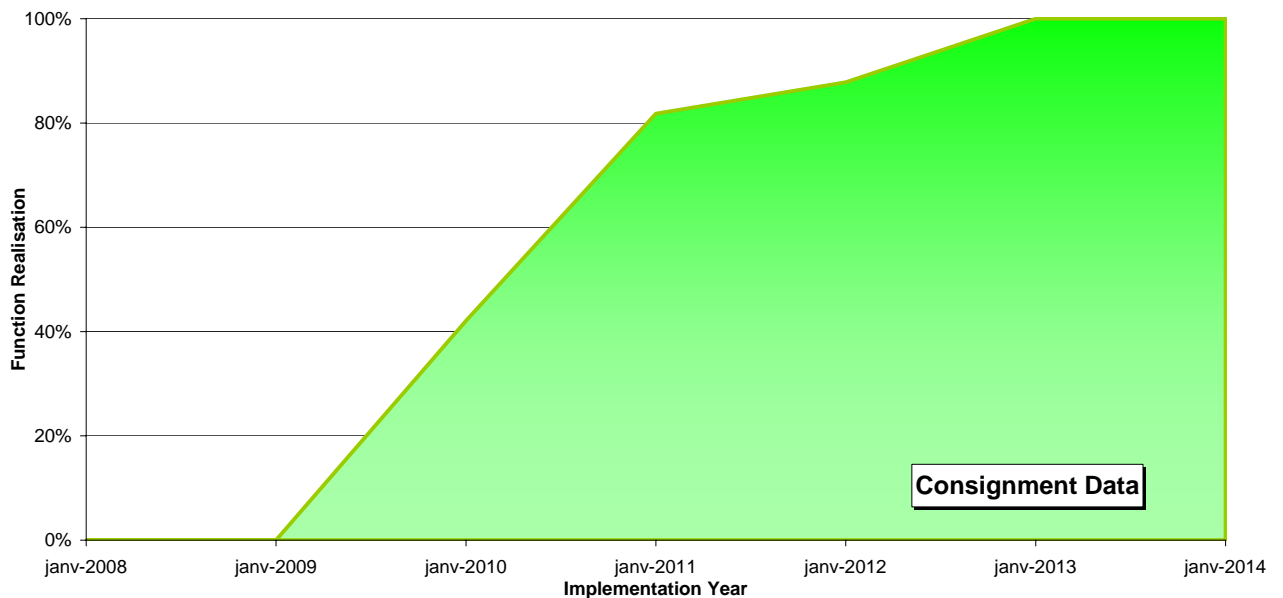

4.1.2.3.2 Realisation of the WIMO Function (Milestone)

Many RUs have existing capabilities to meet the requirements of this function, illustrating that 40% of the RU community can comply with the requirements early in the SEDP. The coherent late deployment timeline at the end of the SEDP illustrates the integration of those without current capabilities in low-risk, phased approach.

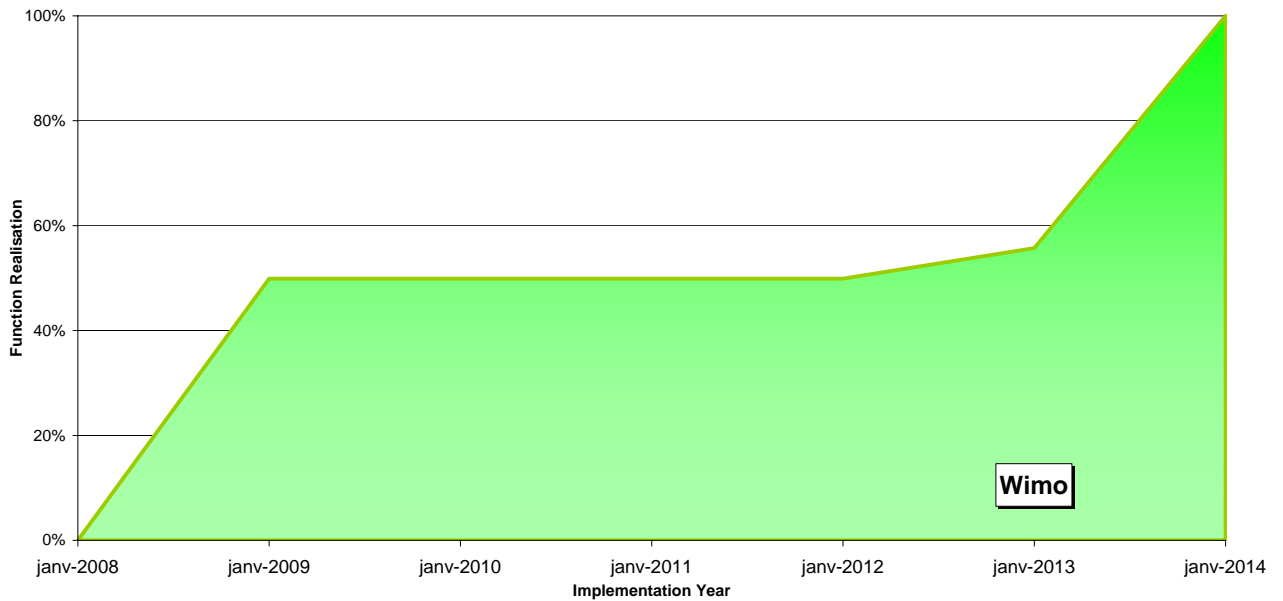

4.1.2.3.3 Realisation of the Wagon Movement Function (Milestone)

There is existing functionality for the Wagon Movement function, like the WIMO Function as stated above. The graph below reflects that nearly 40% of the RU community can comply with the requirements early in the SEDP. The coherent late deployment timeline at the end of the SEDP illustrates the integration of those without current capabilities in rapid deployment approach.

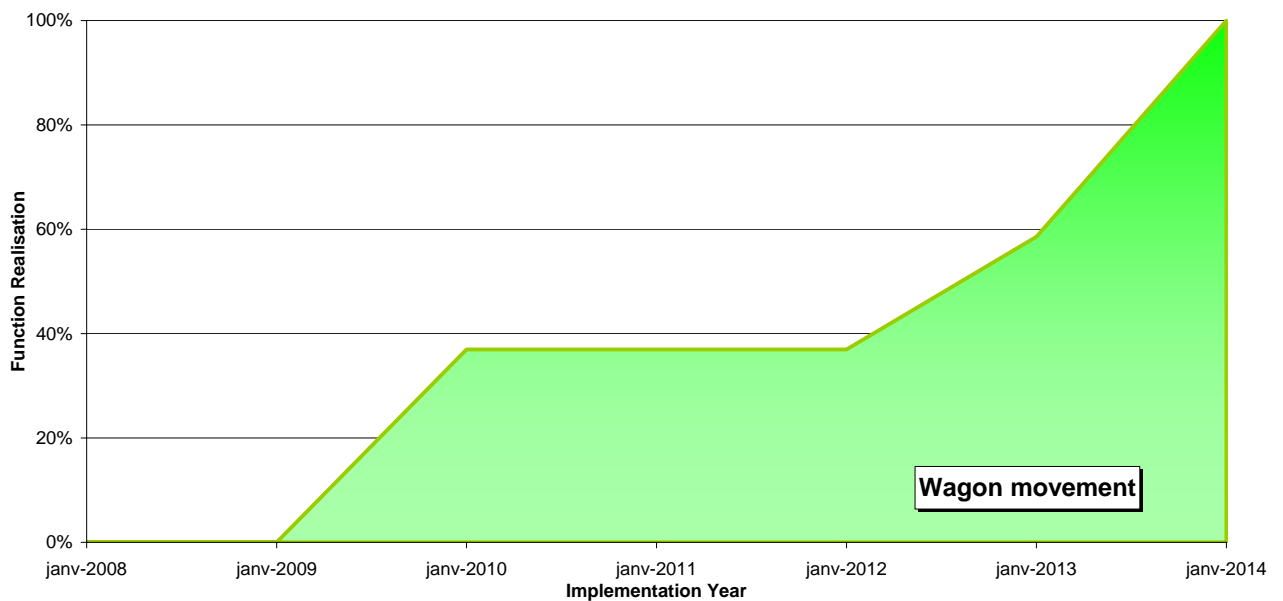

4.1.2.3.4 Realisation of the Shipment ETA Function (Milestone)

The Shipment ETA Function reflects a coordinated and coherent implementation at the end of the SEDP. Due to the enormous effort involved in the realisation coupled with the dependence on earlier functions, this function is well-coordinated and consistent across the industry.

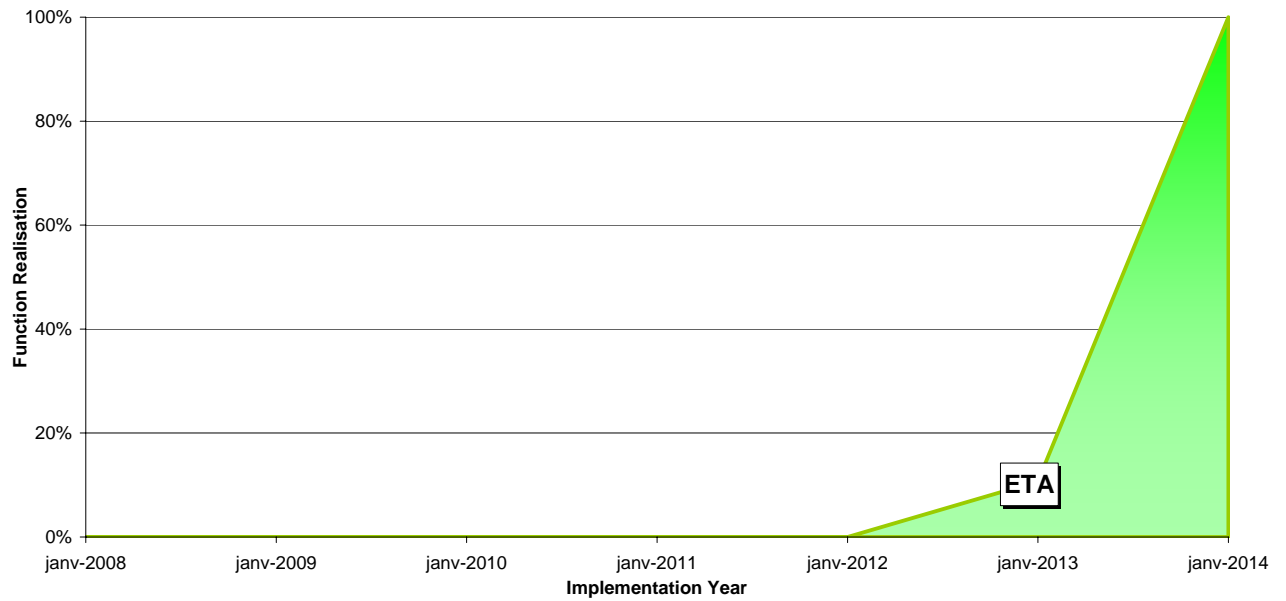

4.2 Existing International Systems

4.2.1 Orfeus (ORF)

4.2.1.1 Overview

The ORFEUS system is a central platform used by different Railways to exchange consignment note data about cross-border traffic.

The ORFEUS system shares information with the International Service Reliability System (ISR) which is central platform used by different Railways to exchange production wagons status events messages.

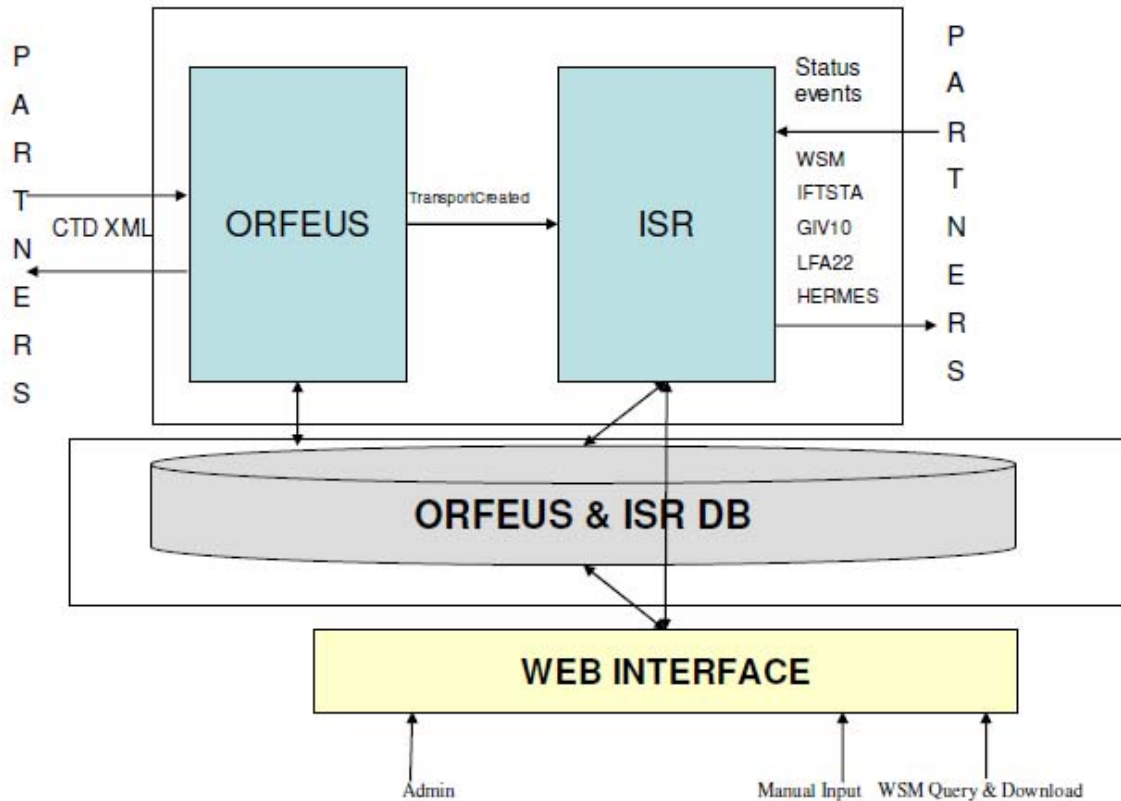

4.2.1.2 Function Key points

4.2.1.2.1 Create Transport Dossier

- validation of message
- acceptance of message
- identification and storage of detailed route
- identification of role for each carrier
- storage of consignment information
- routing rules
- filters depending on role and position
- export of transport description and event to ISR
- global result of processing

4.2.1.2.2 Update Transport Dossier / Delete Transport Dossier

- prepare in the data model management of change of route, change of role, change of position, change of transport data

4.2.1.2.3 Management of routing rules

- depending on contract and role/position
- depending on role/position
- modified by an admin using an HTML application

4.2.1.2.4 Management of validation rules

- Validate value



- Validate format
- Validate integrity of message :
- Validate the presence of a structure depending on the existence of another field,
- Validate the presence of a field depending on the existence of another field,
- Validate the presence of a field/structure depending on the value of another field,
- Validate the value of a field depending on the value of another field,
- Validate the same value for all occurrences of a structure

4.2.1.2.5 Management of acceptance rules

- rule based (tests on fields and combinations of fields). Supported actions are to accept, reject and accept without forwarding. Some of these rules can be easily en-/disabled

4.2.1.2.6 Management of filters rules

- rule based
- depending on role and position of carrier
- modified by an admin using an HTML application

4.2.1.2.7 Management of result of processing

- being able to notify an administrator online of the processing result depending on the type of result (ok, error on message, not accepted..)
- automated production and distribution of daily error reports
- applies to CDS management of automated recovery points in case of internal failure (before acceptance, after acceptance of message, after notification to a partner)
- management of audit trail of consignment.

4.2.1.3 SYSTEM DESIGN

The diagram below illustrates the ORFEUS system design. The system is described as a set of modules, for each module functional and technical functions and nature are described.

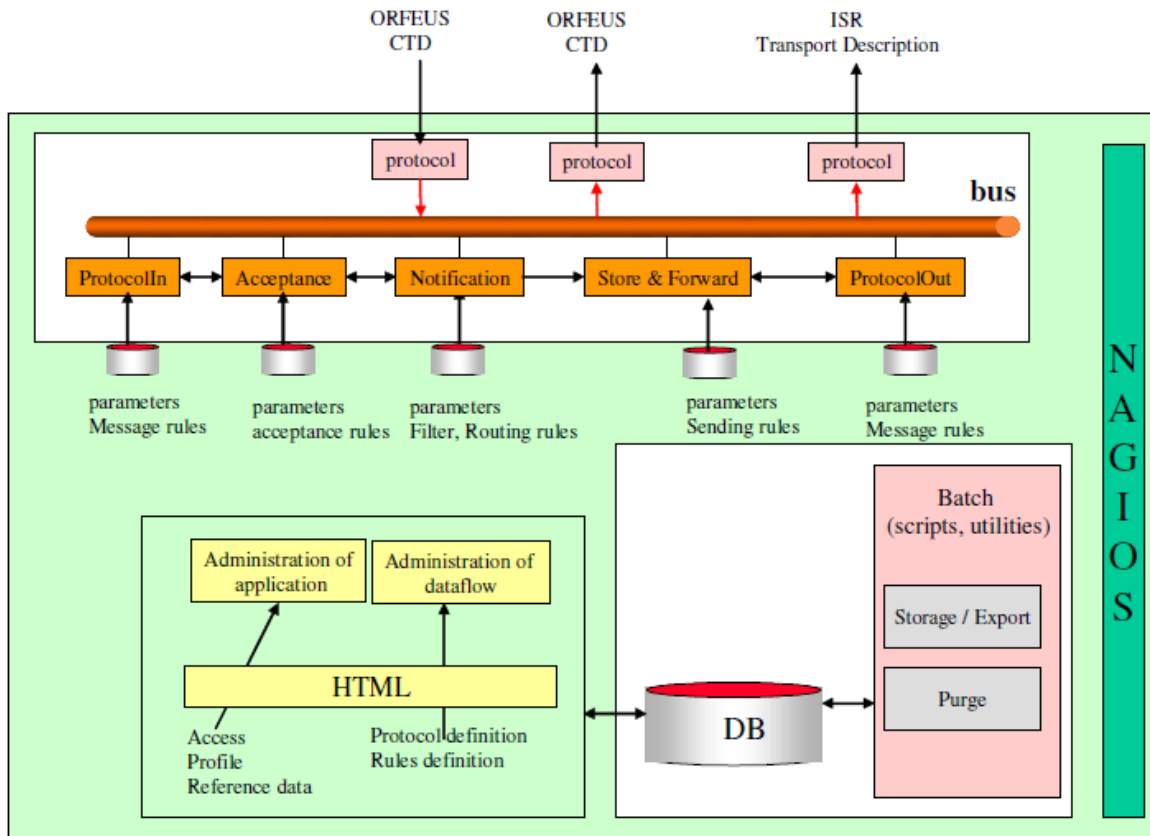

4.2.1.4 System Architecture

The system is running on 2 Application servers communicating by Intertango. The partners and flows are currently distributed on the servers. A global Tango application is defined on each application server. This application manages 2 sub applications: ORFEUS and ISR. These applications could run independently one from another. The ORFEUS application is sending information to ISR (TD) using a file. The Database Server stores 2 Databases : ORFEUS and ISR. The ISR Database keeps the actual data model and ads some tables for audit trail. The ORFEUS Database is evolving to take into account new data models.

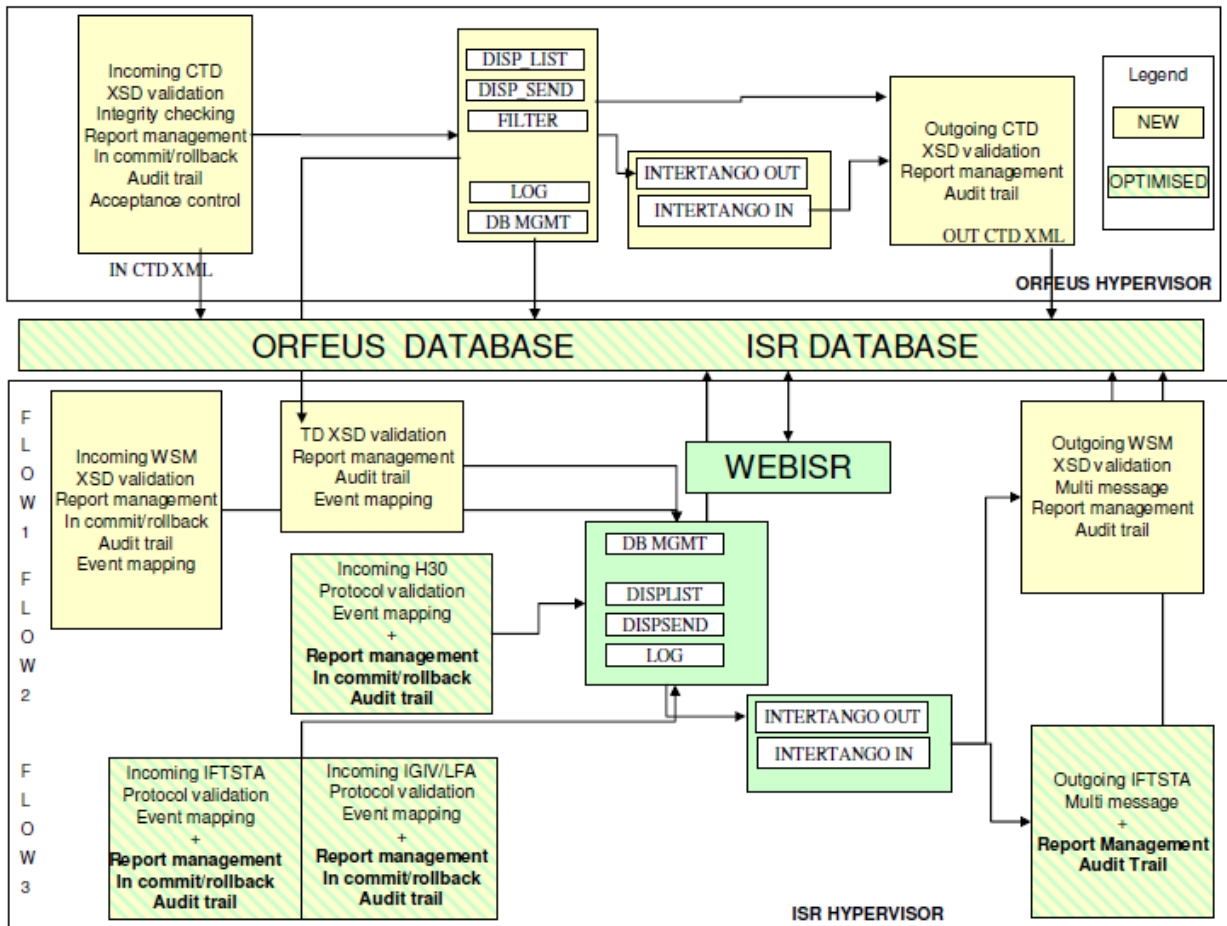

4.2.2 International Service Reliability (ISR)

4.2.2.1 Functions

4.2.2.1.1 Train Pre-Advice Message

The exchange of the Train Pre-Advice Message via ISR for border crossing trains from a RU to the following RU contains the data needed for all wagons

- to transport them without any stop to the next handling yard
- to define the hand-over date/time

4.2.2.1.2 Wagon status

Wagon Status Message for loaded or empty wagons from all participating RUs to all RUs
ISR allows the display the history of events recorded for a wagon or a consignment note. It is used to easily identify by manual comparison of records, all events corresponding to a transport.

4.2.2.2 Wagon events

4.2.2.2.1 Currently supported wagon events messages via ISR

- Create Transport Dossier - distribution of consignment note data
- Start Shipping - first departure of a wagon for a transport (loaded or empty)
- Arrival - (intermediate) arrival in a handling yard
- Departure - (intermediate) departure in a handling yard
- Border Crossing Advice
- Reached Destination - last arrival of a wagon for a transport



Exchanged events are as near to reality as possible depending on the capability of each production system

New events have been realised recently and can be delivered by the railways:

- Ready To Pull (wagon loaded at customer)
- Pulled
- Wagon Broken (transportation interrupted)
- Wagon Repaired (continuation of transport)
- Delivered (to customer)
- Free For Disposition (unloaded, waiting for task)

4.2.3 Existing International IM Applications

In December 2006, 15 CIOs of European Infrastructure Managers endorsed a joint RNE/UIC IT-Strategy proposal to meet the needs of the SEDP and the TAF-TSI implementation. This endorsement was followed by an acceptance at the RNE General Assembly (representing 31 European Infrastructure Managers) and announced at the RNE business conference the following day.

The scope of the joint RNE/UIC IM-IT Strategy is broader than that of the TAF-TSI and includes development of coherent IT tools to meet all of the existing IM business processes. The objectives of this strategy are to define an IT architecture based on:

- Existing systems (domestic and international)
- TAF TSI (Telematics Application for Freight)
- TAP TSI (Telematics Application for Passenger)
- Clearly defined business processes and business needs

Furthermore, the Strategy comprises:

- Business and financing Plan for Developments in 2007/2008 in coordination with UIC
- Initiate new (but necessary) development projects based on the defined strategy
- Interface with and provide input into the Strategic European Deployment Plan (TAF TSI)
- Managing existing and new IT projects Pathfinder, EICIS, EPR, Eurotirails

The following is an illustration of the main IM Business Processes with the corresponding existing international applications and an overlay of the area of scope concerning the TAF-TSI.

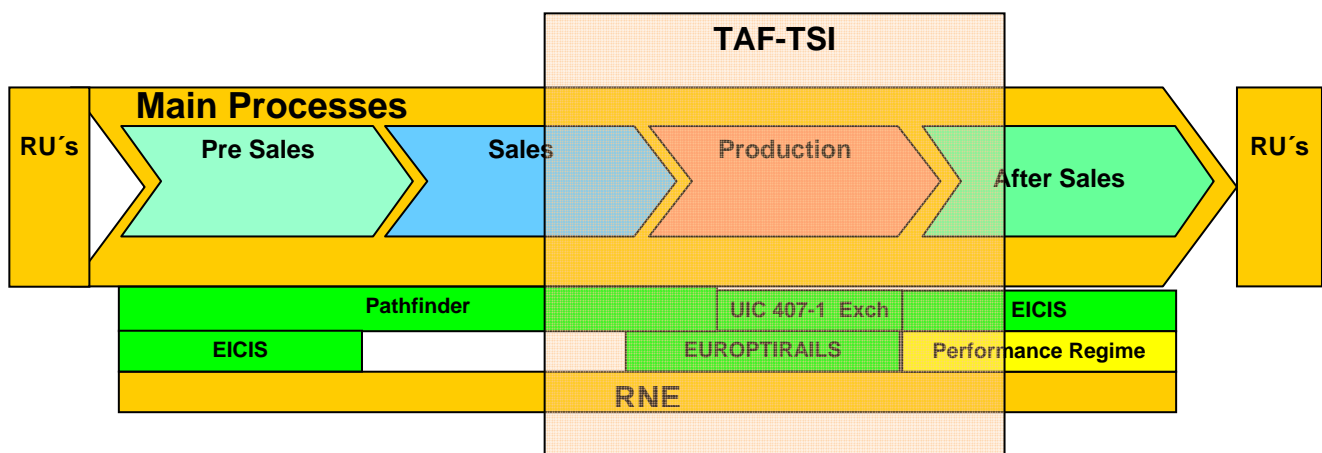

While each individual IM will be entitled to fulfil their individual obligation to the TAF TSI by other non-prescribed systems it is hoped that there will be convergence, in time, toward a common IT landscape based around these existing systems as shown in the diagram.



The TAF-TSI functional requirements to be fulfilled by the IMs are listed below, with the corresponding international application that could be used for compliance:

| Function | Messages | Possible Solution | IM |
|---------------------------|---|---------------------------------------|------------------------------|
| Path Request Function | PathRequest | Pathfinder | |
| | PathDetails | Pathfinder | |
| | PathConfirmed | Pathfinder | |
| | PathDetailsRefused | Pathfinder | |
| | PathCancelled | Pathfinder | |
| | PathNotAvailable | Pathfinder | |
| | ReceiptConfirmation | Pathfinder | |
| | TrainComposition | National System | |
| TrainReady | National System | | |
| Train Function | Preparation | TrainAccepted | optiona National System |
| | | TrainNotSuitable | optiona National System |
| | | TrainPosition | optiona National System |
| | | TrainAtStart | optiona National System |
| | | Enquiry/Response TrainRunningForecast | Europtirails |
| Train Monitoring Function | Enquiry/Response TrainRunningInformation | Europtirails | |
| | Enquiry/Response TrainDelayPerformance | Europtirails | |
| | EnquiryTrainIdentifier | Europtirails | |
| | Enquiry ResponseTrainIdentifiers | Europtirails | |
| | Enquiry/Response TrainsAtReporting Location | Europtirails | |
| | Service Disruption | Europtirails | |
| Main Database | Infrastructure Restriction Notice | Europtirails | |
| Common Reference Files | LocationIdent | ENEE | |
| | CompanyIdent | RICS | |
| Quality Improvement | | Europtirails/EP R | |

It is important to note that the IM-IT Strategy has incorporated the TAF-TSI and SEDP requirements into the overall development plans for the RNE systems. In order to fulfil the requirements as stated by a majority of the Infrastructure Managers in the SEDP responses, the following timeline has been proposed to the members and customers of RNE:



Proposed IM Implementation Plan

| SEDP Functions | 2007 | 2008 | 2009 | 2010 | 2011 | 2012 |
|--|------|----------------------------|----------|------------|-----------|------|
| Common Interface | | All Applications | | | | |
| Train Movement | | Europtirails | | | | |
| Reference Files Infrastructure Restr. | | Pathfinder Europtirails | | | To define | |
| Train Preparation | | | National | | | |
| Ad hoc Path Request | | | | Pathfinder | | |

RNE Business Conference 2006

November 2006

9

4.2.3.1 Path Request Function and Pathfinder

4.2.3.1.1 TAF-TSI Requirements

According to the TAF-TSI, due to exceptions during the train running or due to transport demands on a short time basis, a railway undertaking must have the possibility to get an ad hoc path on the network. This is also set forth as a requirement in Art. 23 of EU Directive 2001/14.

In the first case, immediate actions have to be started, whereby the actual train composition based on the train composition list is known.

In the second case, the railway undertaking must provide the infrastructure manager with all necessary data concerning when and where the train is required to run together with the physical characteristics in so far as they interact with the infrastructure. These data are mainly given in the supplemented consignment note respectively in the wagon orders.

The Path agreement for a train movement at short notice is based on a dialogue between RUs and IMs. The dialogue will involve all RUs and IMs involved in moving the train along the desired path but maybe with different contribution to the path finding process.

The TAF-TSI only addresses the RU/IM message exchange necessary to carry out the short-term path request and does not address the internal IM processes or messaging for the path negotiation process.

4.2.3.1.2 IM-IT Considerations

The gap analysis of the IM IT group of the UIC has shown that the short term path request as required by the RUs and the TAF TSI can be addressed with adaptations to the existing IM IT tools, Pathfinder and Europtirails.



4.2.3.1.3 RU Considerations

The results of the joint RU/IM meeting on July 28th 2006 were summarised by RUs outlining the priorities comprising the RU/IM messages and the establishment of the Common Interface. The first priorities are:

- Establishment of an IM/RU interface to facilitate harmonised communication
- Establishment of a common process and interface for long and short-term Path Request and Allocation
- Implementation of the Train Running Reporting (could be based on Europtirails)

The following diagrams outline the current and desired situation. In figure 1, each RU must establish and maintain a unique interface and support messaging for each individual IM. Moving towards figure 2, the RU may maintain one interface to support the process for all IMs. It was stated that by establishing this interface to support the above-named functionality will provide the basis for all other TAF-TSI functions.

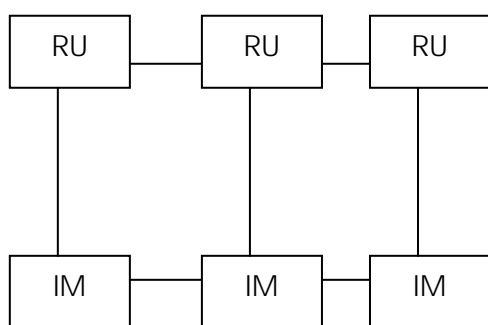
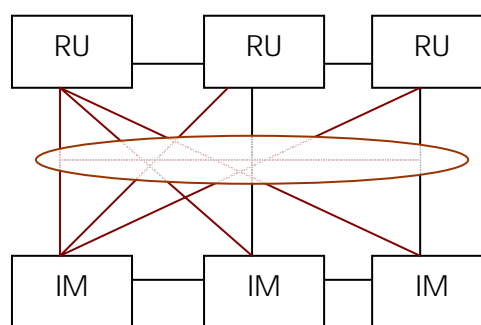

Figure 1 - Current



Additionally the RUs are currently demanding a unique interface and p Figure 2-Desired t long-term path planning as well as short-term path requests, which are handled

in the operational IM processes. It was clear the RUs did not want to support multiple interfaces and processes for contracting for each IM.

Therefore it is proposed to leverage the existing systems to handle both long-term and short-term path requests, in line with the overall IM-IT Strategy Architecture.

4.2.3.1.4 Pathfinder Timetabling Functions and General Architecture

The table below illustrates the timing considerations for capacity requests outside of the network statement publication process.

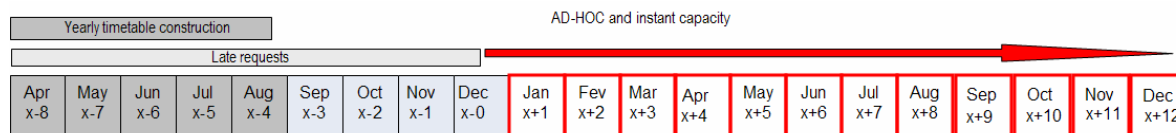

Network statement publication (M-12)

The actual timetabling process starts with the publication by each IM of the Network statement according Directive 2001/14/EC. The Network Statement is published 12 month before the next timetable period and 4 months before the deadline for requests for infrastructure capacity. This process is part of the Yearly Timetable Construction that is covered by the handbook for the international timetabling process.

Deadline for capacity requests (M-8)

The applicant makes his requests for Infrastructure capacity for the coming timetable period before the second Monday in April.



It is assumed that the Yearly timetable construction is covered by the handbook for the international timetabling processes.

The directive is not mentioning any difference in time frame for paths orders coming after the second Monday in April to allocation of path at very short notice. As a matter of clarity for customers, Infrastructure Managers are discussing the definition of three period types:

- Late requests
- Ad-hoc train paths requests
- Instant capacity

LATE REQUESTS:

These paths requests concern orders coming after the 2nd Monday in April until 5 working days (Mon to Fri) before the timetable starts in December.

- Paths are treated on the basis of first in first served.
- Allocation is done either using remaining path catalogues or the remaining capacity giving the best possible answer.
- If there is a conflict priority rules are applicable according to national rules.
- Pathfinder could be the common tool for ordering, harmonizing and answering. The publication (Paper or electronic) of timetable does not interfere in this process.
- Border checking process (RNE Procedure for train passing through border points between IMs) is applicable for harmonization. Every IM should endeavor to use the contact list provided in the document and are responsible for organizing joint regular contacts. This process enables schedulers to make the appropriate direct and fast contacts.
- Each IM may have specific rules for answering to customers which could be detailed in IMs network statement; however a harmonised answer will be given for the final answer.

Answers to such requests will not be given before the end of the final answers to customer’s period. (Period ending the 19th Friday after deadline for path request).

AD-HOC REQUESTS:

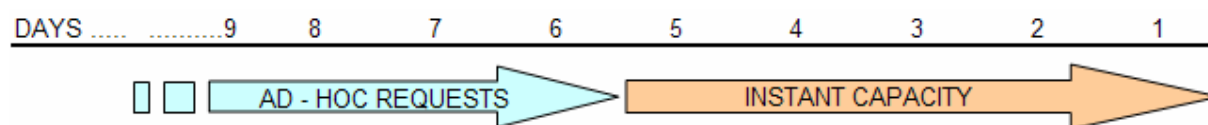

- These paths requests concern orders coming 5 days before the timetable starts in December until 5 days before the train runs.
- Path requests are treated on the basis of first in first served.
- Priority is given to the earliest request submitted.
- Allocation is done in the remaining capacity giving the best possible answer.
- As far as they are still available, allocation shall be carried out using catalogue paths.
- Pathfinder could be the common tool for customers ordering a path and IM to harmonise.
- Border check document (RNE Procedure for train paths through border points between IMs) shall be used using the appropriate contact and location for dealing with ad-hoc requests.



- The EU directive mentions that “the infrastructure manager shall respond to ad-hoc request for individual train paths as quickly as possible”. It is assumed that this is applicable to a limited number of paths to be treated within 5 days.

In case of:

A subsequent number of requested paths

Specific constraints requested for the path

Extra gauge

Train parameters which require a specific IM study

The response may take longer than 5 days. The customer will be informed on when he will receive the detailed answer

INSTANT CAPACITY (Concept)

- These path requests concern orders coming between 5 days and 1 hour before the train run.
- Answer is given to the customer as soon as possible as long as the request is consistent.

As a quick and reactive answer is necessary, it is foreseen that the customer may accept a lower quality path at this stage. Paths will still be granted in some cases, but the IM will not be in the position to give details timing at stations and borders. Time windows will be given.

- Europtirails for example may be the controlling tool for handling such capacity. Details shall be provided to customers as long as the situation allows.
- Allocation of remaining capacity using remaining catalogue paths.
- Path is allocated, however temporary conflicts may still exist and are sorted out according to the real time situation of trains running by control centers.
- The EU directive mentions that “the infrastructure manager shall respond to ad-hoc request for individual train paths as quickly as possible”. It is assumed that this is applicable to a limited number of paths to be treated within 5 days.

In case of:

A subsequent number of requested paths

Specific constraints requested for the path

Extra gauge

Train parameters which require a specific IM study

The response may take longer than 5 days and the customer will be informed on when he will receive the detailed answer.

As far as this project is concerned, Pathfinder is not foreseen to be the tool for coordination and harmonisation. However, Pathfinder could be used as a communication and interface (messaging) tool.

Europtirails may be the controlling tool for managing such capacity in association with Pathfinder. Pathfinder is the common tool for customers ordering a path and for the IM to harmonise, making the connection with Europtirails. Allocation will be done in the remaining capacity using catalogue paths.



4.2.3.1.5 Existing timetabling tools

Pathfinder

Pathfinder manages the information flow between the Railway undertaking and the Capacity Managers of the IMs for long and medium term path requests.

Europtirails

Europtirails assists the operational phase of the train run. The path assembly allows operational traffic control centres to re-discuss the path for a train in case of service disruptions.

Comparison

| Pathfinder vs. Europtirails | | |
|-----------------------------|---|--|
| 1 | Manages communication between IMs and RUs | Allows only communication between IMs |
| 2 | Path negotiation does not require an agreed train number. | Path assembling must be based on pre-existing Timetable with agreed train number |
| 3 | no communication with traffic management for very short term path requests | Only communication between traffic management centres |
| 4 | Not time critical | Real-time |
| 5 | Mandatory for all RNE members for all international train requests for end of 2006. | In pilot phase on the corridor from Rotterdam to Milan for 6 IMs |

4.2.3.1.6 Gaps and possible solution

Pathfinder is used in the long term timetable planning phase while Europtirails is aimed at the operational phase.

A solution is to use Pathfinder for all train path requests from applicants. This will require Pathfinder to:

- Adapt to a real-time environment
- Communicate with traffic management centres
- Have intelligence of all transition rules between the time tabling services and the operational services for all participating IMS
- Allow transmission of new timetables directly to Europtirails.

4.2.3.1.7 Data Exchange Overview

The following Diagram illustrates the entire process from the original path request from the RU to the path negotiation and final delivery of the path from the IM.

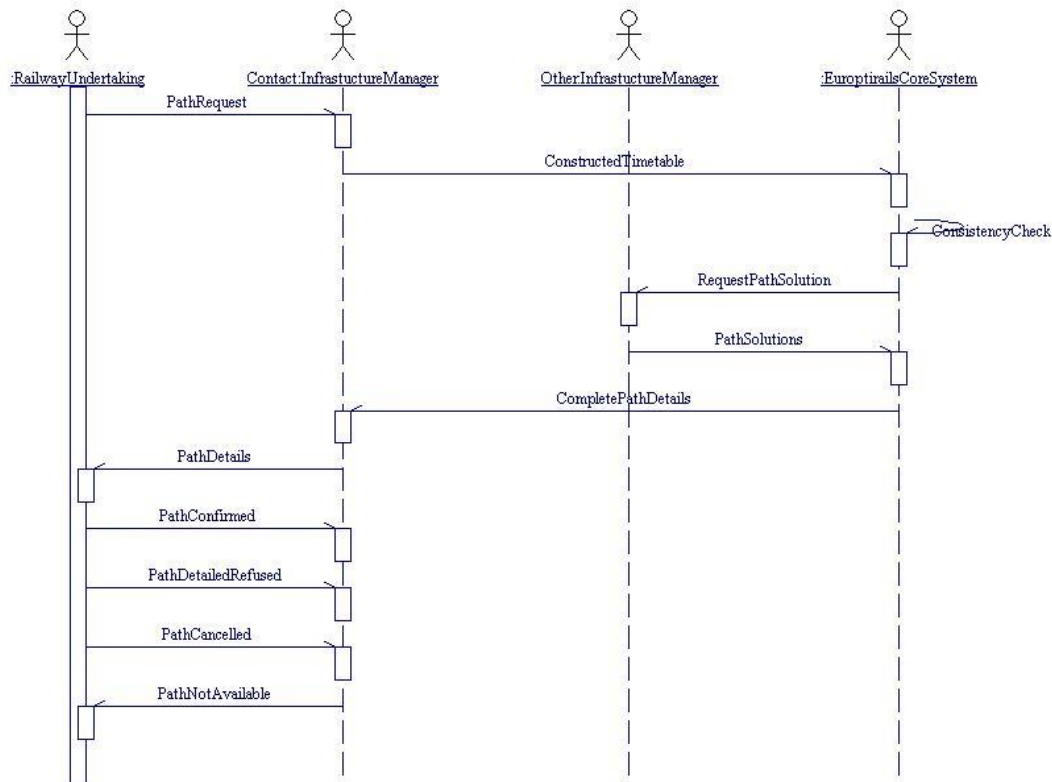

4.2.3.2 Train Monitoring Function and Europtirails

The Train Monitoring Function encompasses the following messages:

- Enquiry/Response TrainRunningForecast
- Enquiry/Response TrainRunningInformation
- Enquiry/Response TrainDelayPerformance
- Enquiry/Response TrainIdentifiers
- Enquiry/Response TrainsAtReporting Location
- Service Disruptions

EUROPTIRAILS is suited to fulfil this requirement as its objective is to improve the effectiveness and efficiency of train running on European rail corridors in the operational range through information sharing and support.

The following list sets out the problems that EUROPTIRAILS is designed to assist in solving. The list comes from the project team's understanding of the project and some of the weaknesses of European traffic management identified in previous studies.

The system aims to address the following:

- The lack of responsiveness to the market's needs for information and reliable rail service delivery
- The lack of whole journey based information provision and input to decision making for the Infrastructure Managers
- The different levels of technological exploitation within the Operating Control organisations and the missing of central availability of information



- The lack of technological exploitation in linking the National or Domestic Operating Control Centres
- The lack of recorded information about the performance of service delivery on specific routes against management and control indicators to highlight the actual level of performance achieved in international traffic management.

4.2.3.2.1 TAF-TSI Requirements

The information exchange between RUs and IMs for Train Running Forecast/Advices always takes place between the IM in charge and the RU, who has booked the path on which the train is actually running. In the case of Open Access, which means that the paths for the complete journey are booked by one RU (this RU also operates the train during the complete journey), all messages are sent to this RU. The same is true, if the paths for the journey are booked by one RU via OSS.

This function also specifies the tracing possibility to get information about train location. The RU may send an enquiry to the IM about its trains at any time. The RU may enquire about:

- the running of the train (last recorded location, delays, delay reasons),
- a train's performance (delays, delay reasons, delay locations),
- all identifiers of a specified train,
- train forecast at a specified location,
- all train running forecasts for a specified location.

The access to this information must be independent from the RU / IM communication during the train run, which means that the RU must have a single access address to this information. The information is based mainly on the stored message exchange as mentioned above.

4.2.3.2.2 Europtirails Functions and General Architecture

The system provides three primary functions that are:

- On-line centralised information supply to Infrastructure Managers as well as other authorised users (e.g. RUs)
- Data Recording and Monitoring to provide management reporting and performance indicators
- Path Assembly for supporting IMs in train re-scheduling.

These functions, which are designed to address the corridor as a whole or in part, are outlined below respectively as:

- Information Model
- Monitoring Model
- Path Assembly Model

Information Model

The objective of the centralised information function is to provide data to users as continuous flow or in response to their requests.

These data concern real-time train running and the corridor status, as defined in the following.

- Source of data will be in general the domestic control and traffic management systems of the partnering IMs in addition to manual input, where necessary.
- When EUROPTIRAILS does not have the data available to answer the request, it will attempt to obtain the data and make them available.
- The system will give an indication to users making requests as to its ability to reply to their requests.
- It shall always give users a response to their requests. This response might be the answer to the request, or an advice that the system cannot respond soon, but it will later. On the other hand the system will prompt specific users for single answers. Other requests will



- initiate a flow of data that the system will make available as soon as it becomes available.
- EUROPTIRAILS uses a standardised protocol for data exchange. The general principles affect all the other EUROPTIRAILS functions as well.

Monitoring Model

The objectives of the Monitoring Model (MM) are:

- to provide recording data about the running of Trans-European passenger and freight trains and
- to provide other Corridor's performance records, in order to identify the strengths and weaknesses of the current method of service delivery and provide Infra Managers, as well as other Stakeholders, with basic information for other planning and policy purposes.

In particular the MM shall

- provide detailed information concerning EUROPTIRAILS trains on the whole network, on certain reporting points or certain relations, in order to
- measure and analyse the quality of services
- trace weaknesses and responsibilities of the operations processes
- introduce actions to improve performances and process quality
- measure and analyse the effects of improvements.

The MM involves EUROPTIRAILS trains. However analyses about these trains are not restricted to the corridor, according to the available information, as above said.

4.2.3.2.3 IM Considerations

The Train Monitoring function is now currently handled by direct communication between the IM and the Contracted Applicant (RU) on a bi-lateral basis. Most of the Infrastructure Managers currently have the capability to send 'push' messages for Train Forecast/Running Advices to the RUs in the agreed 407-1 or proprietary formats.

The Europtirails system is currently used as a back-office application for the Infrastructure Managers and has no actual connectivity to the RUs. In the current case, the IMs receive information directly from Europtirails into their current application and forward a message in the agreed format to the contract RU.

Additionally, the Europtirails system is limited to international trains crossing at least one border of the EUROPTIRAILS corridor and crossing at least two of the additional agreed passing points. The current geographic of Europtirails is illustrated below:

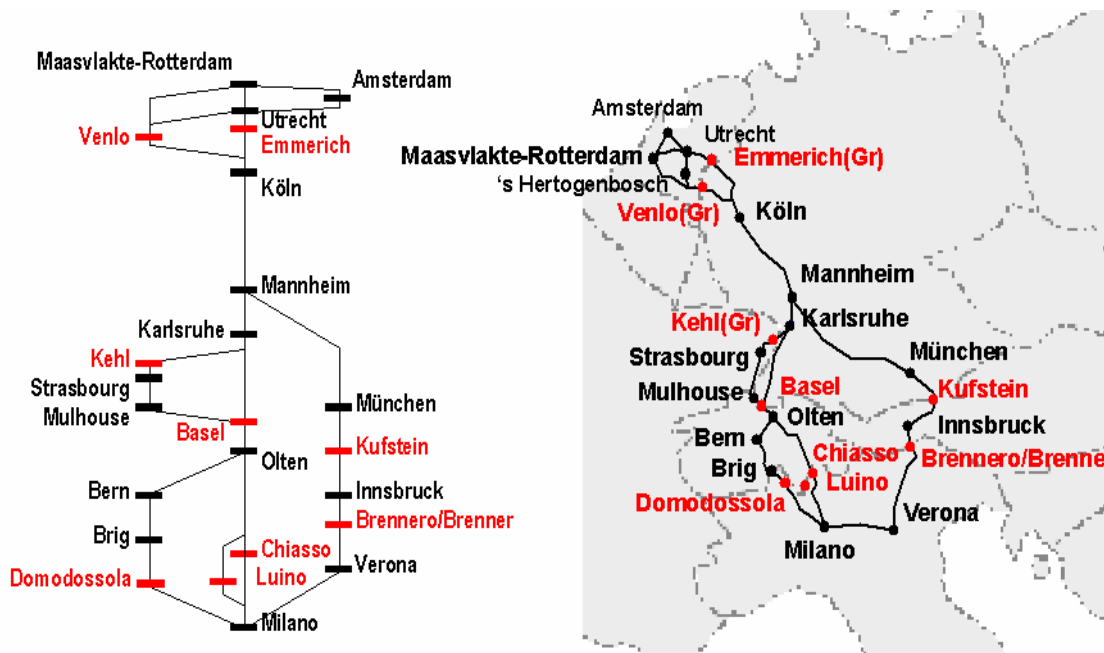

The diagram above represents Prototype I, with a planned expansion in Antwerp, Basel and Italy. In order for Europtirails to be a viable solution for TAF-TSI compliance, the scope of train reporting will have to be increased, perhaps phased in on a corridor basis.

4.2.3.2.4 RU Considerations

Railway Undertakings can access the Europtirails system for information gathering. Outside Europtirails the RU can interact with IMs for reaching agreements about current traffic situations. In the present scope of the project the results of these interactions are required to be input to the system through the IMs who therefore remain the only responsible bodies for data management.

In order to take advantage of the Europtirails functionality, RU may be able to connect directly to the system – or continue to receive messaging from their IM partner as established in the TAF-TSI.

4.2.3.2.5 Gaps and possible solution

The IM-IT Strategy has endorsed the use of Europtirails to meet the required monitoring function. However, several developments must be made to:

1. Use Europtirails to meet the requirements of this function
2. Extend usage of Europtirails
 - a. To include all interoperable trains
 - b. To include more IM participants
3. Adapt Europtirails to
 - a. Send messages to RU's
 - b. Allow enquiries from users

4.2.3.2.6 Data Exchange Overview

Below is an example of current Europtirails usage, limited to IM communications:

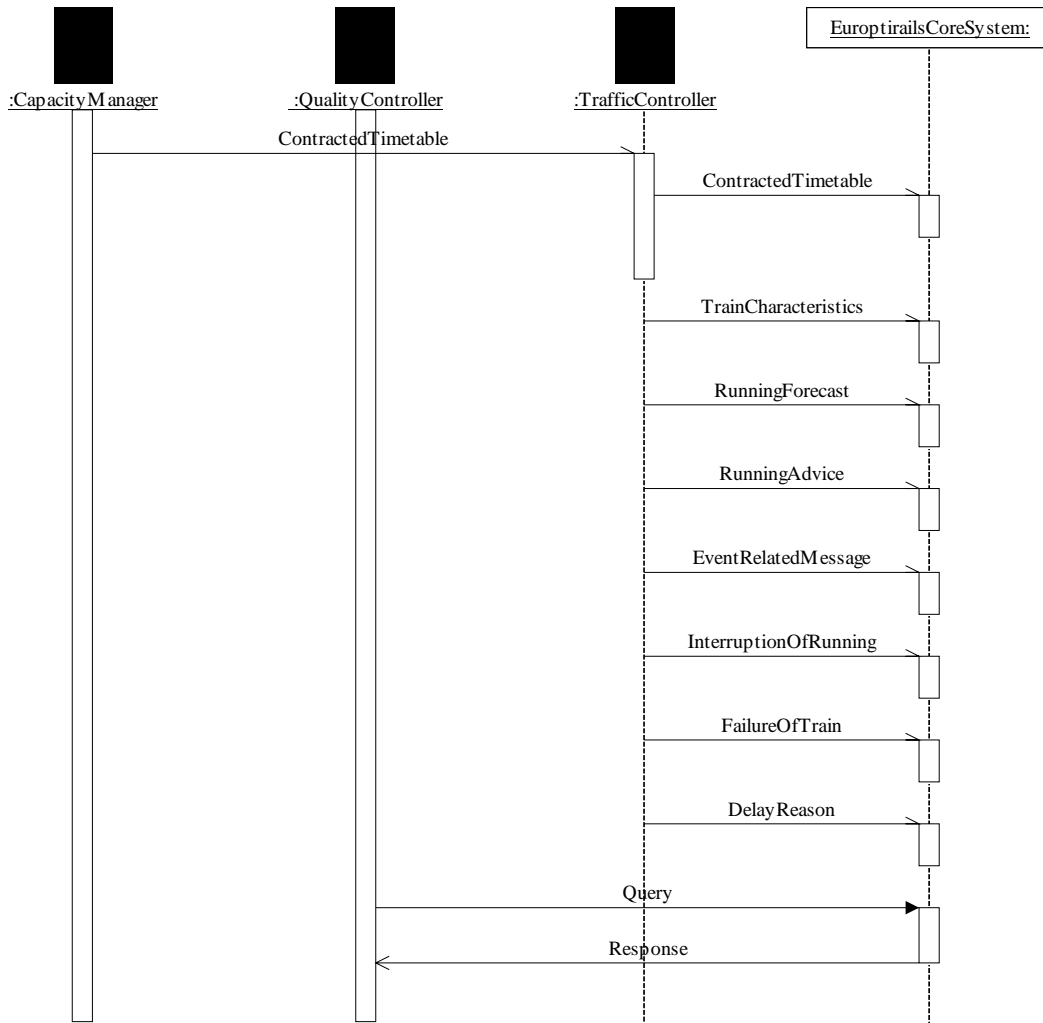



The RU has been added in the target diagram.

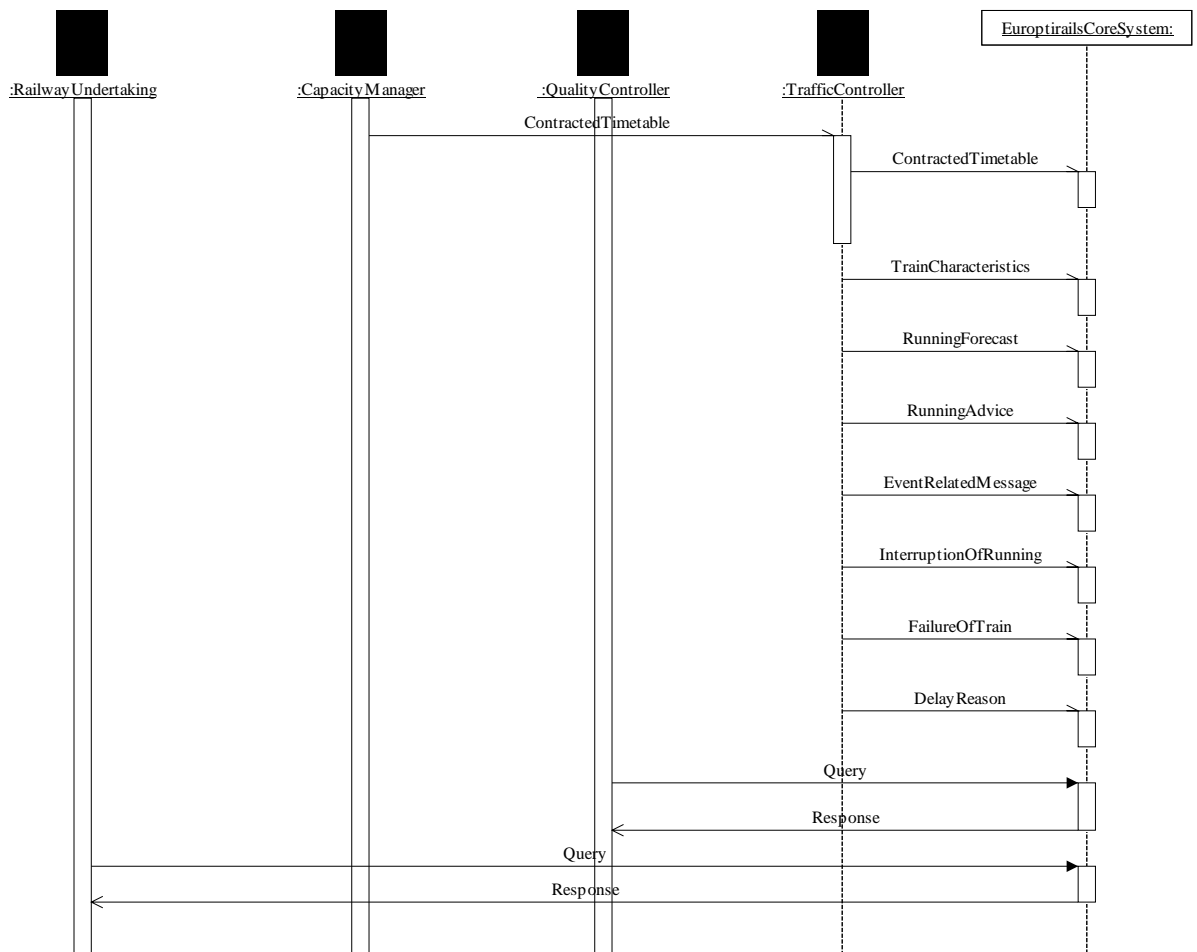



5 Risk Assessment

Several Functions from the TAF TSI have received responses from the Railway actors which differ in planned implementation by a few years. These differences or gaps need a careful analysis in order to evaluate the consequences and propose appropriate compromise solutions.

The following risks have been specifically studied during the course of preparation of this plan and addressed by the Steering Committee.

Material Risk 1: Only mandatory elements of TAF TSI are included in the SEDP.

Industry Response: Non mandatory functions related to the TAF TSI can be implemented by each actor in the European Rail Industry, therefore they are not needed in the SEDP.

Material Risk 2: A decentralised WIMO architecture requires all Actors to have large, sophisticated data bases with the capability of rapid responses to complex and varied inquiries from; RUs, Customers and Fleet Managers.

Industry Response: The European Rail Freight Industry considers for business reasons that Wagon & Intermodal Operating data must be stored in databases of their choice whether individual or shared, not one centralised database.

Material Risk 3: The impact of implementing multiple systems at the same time in RUs may cause delays.

Industry Response: The concurrent implementation of wagon movement reporting, train information, wagon & intermodal operating data and ETAs will be completed in a phased way over a period of time, avoiding the risk of delay by implementing several systems at the same time.

Material Risk 4: Adhoc Path Request may be realised in some RUs before some IMs.

Industry Response: If the Ad Hoc Path Request functionality is available early at some RUs it will be used to communicate the request to IMs using whatever current mechanism available at the IM.

Material Risk 5: RU Customer prioritisation may change during the project

Industry Response: Whether RU prioritisation changes or not during the project, the SEDP responses from RUs have taken into account the difficulties of implementing each TAF TSI function. In any event, the plan will be frequently monitored over the course of its implementation and reviewed as necessary



6 Governance structure for the TAF TSI implementation

6.1 Purposes of Governance

The functions of TAF TSI Governance are described as:

- Coordination and consultation – the Railway Associations themselves plus a Steering Committee .See 6.2
- Monitoring and Policy – The EC and the Railway Associations .See 6.3
- Operation Organisation – See 6.4

Intermediate phase & Coordination of the Railway Sector

- existing Steering Committee as the interface to the Commission (See 6.2 and 6.3)

6.2 Steering Committee & Railway Associations

Due to the fact that TAF TSI is a Regulation (and not a Decision through the Member States) the Governance requires top level direction through a Steering Committee similar to the one which has steered the preparation of the SEDP itself.

The overall framework of the Governance structure for the implementation phase is proposed below. The actual organisational structures will be defined within the preparation stage.

The governance structure needs to be lean, efficient and wisely occupied. A three level hierarchy is appropriate for the task. There should be two teams assigned to the TAF TSI and its implementation.

One team is dedicated to the Deployment Manager and oversees the deployment of the TAF TSI itself: It provides coaching and consulting to the entities in the ERFI so that the implementation is done in sensible steps at moderate costs. This team helps the entities set up and finalise their deployment strategy. Furthermore, this group tracks milestones and activities to assure functional and regional progress. The deployment group is responsible for conflict resolution between quickly changing technologies, reliable IT component life cycles and cost cutting. This function could be provided by the UIC.

The head of the deployment group is the Deployment Manager. The Deployment Manager will act as the overall Programme Manager, coordinating the day to day implementation activities and providing input to the Steering Committee on a regular basis. This must be a full-time position, responsible to the Chairman of the Steering Committee.

The operation group is responsible for the development and maintenance of the Common Interface and the Reference Files. In addition, it defines and monitors access rules plus security aspects. The main task is to connect new companies (RU/ IM/ WK) to the CI. This group is lead by the operation manager and could be drawn from existing organisations, e.g. RNE for the Infrastructure Managers and Raildata for the Railway Undertakings. While implementing the TAF TSI through the years, the operation group will become more and more active whilst the deployment group becomes less active. The operation group is also responsible for technical advisory and the procurement of spare parts/ new components for the CI and the reference files.

The exact size of the groups working under the Deployment and Operation Manager will depend on the actual workload, resulting from the various deployment approaches. Both managers must work closely together and coordinate their activities.

The Deployment Manager and the Operation Manager may request the Chairman of the Steering Committee (SC) to call a specific additional meeting of the SC for a decision on strategic issues, if necessary, outside of the normal pattern of SC meetings.



The Steering Committee will set the policy, strategic direction and prioritisation for the TAF TSI implementation according to the requirements of the SEDP and is also be responsible for overall programme quality control. The Deployment Manager/Programme Manager will undertake the co-ordination, synchronisation work within the timeframe, defined by the SEDP.

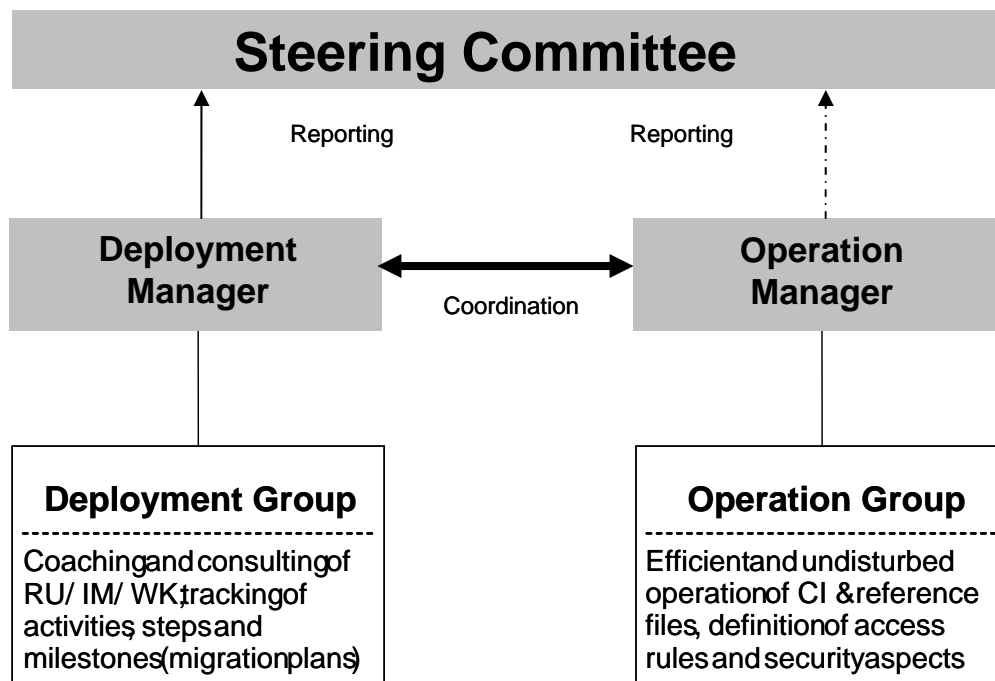

The Deployment Manager reports periodically to the Steering Committee. The Steering Committee comprises high level experts from the stakeholders and representatives from associations (UIC, ERA, CIT, CER, EIM etc.). The Steering Committee discusses recent developments and challenges and acts on decisive issues. Furthermore, the Steering Committee should have the right to decide and recommend financial issues (budgets) for the implementation team (operation and, deployment groups).

The main responsibilities of the Steering Committee are:

- Steering and prioritising the implementation programme
- Support the Programme Management staff
- Decision on any modifications of the TAF TSI implementation approach and of adaptations of the requirements
- Steering common Freight Railway interests in the context of TAF TSI
- Definition of transparent rules how to deal with non-adherence to SEDP plans

The Steering committee will meet as often as deemed necessary and at least twice a year and will be supported by a Programme Manager who will follow the implementation process and report as required to the Steering Committee.

It is the responsibility of the Chairman of the Steering Committee to report to the EC about progress, the current project status and the next steps to be taken, supported by the Steering Committee Members.

The main responsibilities of Deployment Management are:



- Maintaining confidentiality of the commercial and economic interests of organisations implementing the SEDP
- Ensuing co-ordination of the implementation of TAF TSI steps
 - o Support of individual TAF TSI implementation teams
 - o Assist in the co-ordination of ongoing IM and RU IT strategy
- Monitoring of the TAF TSI implementation
- Overall progress reporting of the TAF TSI implementation status to the Steering Committee
- Initiating, organising and managing of appropriate TAF TSI related communication

Following the conclusion of the SEDP project, there will be a requirement to coordinate and respond to political and planning questions prior to the start of the implementation programme itself. A process will be agreed by the Steering Committee as to how this will be handled

6.3 Monitoring and Policy

It is proposed that nominees from Steering Committee in 6.2, to include the Chairman, will meet at regular intervals with the EC, to serve as a formal communication channel between the Railway organisations and the EC in matters relating to the monitoring and policy issues associated with the implementation of the SEDP.

6.4 Tasks of an Operations Organisation

Following the submission of the SEDP the railway organisations will review and propose how the operational aspects of the TAF TSI will be managed, in the future, having regard to the following tasks which will need to be performed:

6.4.1 Administration

- a. Implementation of an on-going business model
- b. Human resource management
- c. Management of the legal implications
- d. Relationship management
- e. Integration of new users
- f. Marketing of the products and services

6.4.2 Finance

- a. Defining agreed payment rules for the users
- b. Billing of the participating entities

6.4.2.1 Contract management

- a. Contract management with suppliers (Service level agreements)
- b. Documentation of the tasks and obligations of the suppliers in
 - Framework agreement that regulates the collaboration (tasks and obligations) between the Operations Group (Customer) and the Supplier
 - in Addendums that describe the services agreed upon and regulate the provisions for providing these services to the Customer.
- c. Contract management with participating entities (each entity e.g. RU, IM, wagon keeper has to sign an individual contract with the operations group)

6.4.2.2 Tendering

- a. Managing calls for tender with suppliers



- b. Negotiation with suppliers
- c. Selecting suppliers

6.4.3 Management of outsourced IT functions

- a. Manage based on an operations agreement regarding either software management, operational support or a facility management task

6.4.3.1 Management of IT development

- a. Initiate IT development based on user needs
- b. Initiate adaptations on existing applications
- c. Integrate new functions
- d. Decide in house realisation via outsourced development
- e. Prepare detailed specifications
- f. Manage outsourced development based on a development agreement that may include all phases from the analysis to the realisation and implementation of the solution.

6.4.3.2 Test-Management

- a. Installation of a system environment for testing activities
- b. Running of technical and stress tests
- c. Running of functional tests

6.4.3.3 Change Management

- a. Handle TAF TSI change requests
- b. Install an appropriate change management
- c. Install an appropriate release management

6.4.3.4 User support

- a. Develop the necessary documentation (with suppliers)
- b. Produce the required manuals (with suppliers)
- c. Offer training sessions for the ERFI
- d. Offer helpdesk service (with the suppliers)

6.4.3.5 Quality improvement

- a. Initiate quality measures
- b. Recommend data improvements activities
- c. Monitor data quality and generate reports. Principle: The ERFI is responsible for the quality of the entered data.

6.4.3.6 Monitor performance

- a. Improvement measures
- b. Performance Tests

6.4.3.7 Manage confidentiality requirements

- a. Introduce transparent rules for user identification
- b. Enforce safety procedures to ensure that no unauthorised individual gains access to the system



- c. Initiate regular IT audits
- d. Initiate regular audits to demonstrate that the centrally stored data are used only in accordance with the rules
- e. Introduce confidentiality rules to protect the sensitive data
- f. Monitor database security

6.4.4 Reference Data management

6.4.4.1 Monitor quality and consumption parameters

- a. Maximum CPU consumption
- b. Maximum disk consumption per month
- c. Number of licences
- d. Uptime percentage

6.4.4.2 Reporting

- a. Ensure the reporting within the Governance structure



7 Investment Estimation and Procurement strategies

7.1 Investment Estimation

The effort and investment for the realisation of the requirements of the TSI Telematic Applications for Freight will be different between individual stakeholders as the existing systems cover the requirements of the TSI very differently.

As the individual stakeholders will be formalising their individual investment requirements for the implementation of the TAF-TSI after the approval of the SEDP, the cumulative calculation will provide a new investment base as the project progresses. Therefore, this makes the calculation of lifecycle costs especially difficult. Prior to this formalisation process, the AEIF “*REPORT OF PRESENTATION of the Technical Specification for Interoperability, “TELEMATIC APPLICATIONS” subsystem for Freight Services*” is used as the investment base.

The stakeholders have agreed that this calculation provides the basis of a minimum investment level for the EU 25 of 1533 Million Euros.

7.2 TAF TSI Overall Performance Requirements

The overall performance requirements of the key components of the TAF TSI are as follows.

7.2.1 Batch Performance requirements:

Batch update to reference files and metadata to be undertaken during the hours 0200-0300 CET.

7.3 Procurement Strategies

7.3.1 Introduction

Certain procurement activities will need to be carried out in relation to the implementation of the SEDP of the TAF TSI. Some of these procurement activities will be centralised and others will be limited to individual companies. Other implementation work will be undertaken by internal departments at individual companies.

It is recommended that the EC procures the TAF TSI common components and reference files together with the project co-ordination activities in order to maintain a neutral ‘policing’ approach. It is important that these activities are completed in a timely and in a co-ordinated manner throughout the European rail freight industry.

Calling for tenders or internal procurements for a given part of the project should be carried out in compliance with the overall SEDP. Co-ordination between the different procurements is therefore essential to maintain cohesion of the overall implementation and in particular to ensure that components from other parts of the European rail industry or from centrally-procured projects are available to all at the point expected in the SEDP component plans.

7.3.2 Centralised procurements

Three principle procurements are proposed to be funded by the EC:



- Project Monitoring / Policing
- Procurement of TAF TSI common interface
- Procurement of TAF TSI centralised reference files

It is further proposed that these are undertaken using existing EC TEN/ Mobility/ TSI / Cohesion / ERDF funding and control mechanisms.

7.3.3 Shared Procurements

Upgrades to existing computer systems detailed in this Deliverable (and possibly other systems additionally) will need to be procurement collectively through the management organisation for each of the systems. These procurements should be concluded under the existing procurement arrangements for each organisation. Co-funding from the EC for these procurements should be discussed during 2007.

7.3.4 Individual Procurements

It is expected that all remaining work for implementation of the TAF TSI will be undertaken according to the procurement rules adopted by each individual rail freight industry actor.



Appendix A - Overview for Mandatory TAF TSI Components

| TSI Ref | | Comments | sender | receiver | Impact | SEDP Phase |
|----------|---|---|---------|----------|---------|------------|
| N° | Name | | | | | |
| 4.2.4.3 | TrainRunning Information | This message is issued upon <ul style="list-style-type: none"> – Arrival, departure or run-through in agreed reporting points and/or – Attainment of the agreed initial running time and/or – A new divergence between nominal and actual being achieved in excess of the agreed threshold value | IM | IM/RU | IM/RU | 1 |
| 4.2.8.2 | WagonReleaseNotice | This message is used by the Lead RU – for the case, that the LRU is not the first RU in the Transport chain - to inform the RU in charge, that the wagon is ready to be pulled. | LRU | RU | RU | 1 |
| 4.2.8.3 | WagonDeparture Notice | This message is used by the RU in charge to inform the LRU, that the wagon has been picked-up (pulled) and has reach the RU's Yard of departure. This message is the response to the "WagonReleaseNotice". | RU | LRU | RU | 1 |
| 4.2.9.2 | WagonInterchange Notice | This message is used by the RU/Service Provider to ask the neighbouring RU/Service Provider the acceptance of the responsibility for a wagon. | RU | RU | RU | 1 |
| 4.2.8.4 | WagonYardArrival | This message is used by the RU to inform the LRU, that the wagon has arrived at its yard | RU | LRU | RU | 1 |
| 4.2.9.3 | WagonInterchange SubNotice | This message is used by the RU/Service Provider to inform the IM, that the responsibility is handled over to the next RU/Service provider. | RU | IM | RU/IM | 1 |
| 4.2.12.1 | Numerical Coding for RUs, IMs and Transport Companies | Centrally stored reference file for identification of transport partners in the transport chain | IM/RU | IM/RU | IM/RU | 1 |
| 4.2.8.5 | WagonYardDeparture | This message is used by the RU/Service Provider to inform the Lead RU that the wagon has left the yard | RU | LRU | RU | 1 |
| 4.2.9.4 | WagonReceived_At Interchange | This message is used by the neighbouring RU/Service Provider as answer to the message "WagonInterchangeNotice" to confirm the acceptance of the responsibility for the wagon. | RU | RU | RU | 1 |
| 4.2.11.2 | Infrastructure Restriction Notice databases | These databases contain the description of existing restrictions on the European rail infrastructure. Each IM manages their own database. | IM | RU | IM/RU | 1 |
| 4.2.11.3 | Rolling Stock Reference databases | The keeper of a rolling stock is responsible for the storage of the rolling stock data within a Rolling Stock Reference Database. Databases must be accessible to all service providers based on access rights. | Keeper* | Keeper* | Keeper* | 1 |
| 4.2.12.2 | Wagon and Intermodal Unit Operational Databases | This databases shows the movement of a wagon and of an Intermodal unit from departure through to final delivery at customer sidings with ETIs and actual times at different locations until the final delivery time ETA. The databases also show the different status of the rolling | RU | RU | RU | 1 |

* Subject to change of Regulation by the Commission



| | | | | | | |
|----------|---|--|-------|-------|-------|---|
| | | stock. | | | | |
| 4.2.8.6 | WagonException | This message is used by the RU/Service Provider to inform the Lead RU about deviations e.g. bad order, hold. | RU | LRU | RU | 1 |
| 4.2.9.5 | WagonRefusedAt Interchange | This message is used by the neighbouring RU/Service Provider as answer to the message "WagonInterchangeNotice" to inform the sender of the WagonInterchangeNotice the responsibility for the wagon is refused. | RU | RU | RU | 1 |
| 4.2.8.7 | WagonException Reason | Specified as the Wagon Exception message New ETI/ETA Request. This message is used by the Lead RU to inform the other RU/Service providers about deviations and to request a new ETI / ETA. | LRU | RU | RU | 1 |
| 4.2.8.8 | WagonArrivalNotice | This message is used by the last RU/Service Provider in the transport chain to inform the Lead RU that the wagon has arrived at its yard | RU | LRU | RU | 1 |
| 4.2.8.9 | WagonDeliveryNotice | This message is used by the last RU/Service Provider in the transport chain to inform the Lead RU that the wagon has been placed at the consignee's siding. | RU | LRU | RU | 1 |
| 4.2.14.6 | Metadata | Structure data defining message contents | IM/RU | IM/RU | IM/RU | 1 |
| 4.2.14.6 | PKI | Public Key Infrastructre | IM/RU | IM/RU | IM/RU | 1 |
| 4.2.14.6 | Certificate Authority | Certification authority for PKI | IM/RU | IM/RU | IM/RU | 1 |
| 4.2.14.6 | Repository | Contains necessary information for identifying those participating in the data exchange. | IM/RU | IM/RU | IM/RU | 1 |
| 4.2.14.7 | Common Interface | Common interfaces mandatory for each actor and must handle messaging, encryption, authentication, etc. | IM/RU | IM/RU | IM/RU | 1 |
| 4.2.12.1 | Coding for Rail Locations | Centrally stored reference file for coded rail locations including Primary, Secondary and Zone, Track, Spot (ZTS). This database exists as ENEE. ZTS not needed till Phase 4 | IM | IM/RU | IM/RU | 2 |
| 4.2.12.1 | Emergency Services | Centrally stored reference file of the emergency services, correlated to type of hazardous goods | RU | IM/RU | IM/RU | 2 |
| 4.2.12.1 | European accredited operators | Reference File of all European licensed operators including respective list of national safety certificates granted | IM/RU | IM/RU | IM/RU | 2 |
| 4.2.12.1 | Numerical Coding of Transport Customers | Centrally stored reference file for the Identification of transport customers | RU | RU | RU | 2 |
| 4.2.12.1 | Numerical Coding of Customer Locations | Centrally stored reference file of coded customer locations | RU | RU | RU | 2 |
| 4.2.12.1 | Dangerous Goods, UN and RID Codes | Centrally stored reference file of UN/NA and RID codes for Dangerous Goods | RU | IM/RU | IM/RU | 2 |
| 4.2.12.1 | Identification of Goods | Centrally stored reference file of codes CN and HS codes for the identification of goods | RU | RU | IM/RU | 2 |
| 4.2.12.1 | European maintenance Workshops | Centrally stored reference file of all European maintenance workshops | RU | RU | RU | 2 |
| 4.2.12.1 | European Audit Organisations | Reference File of all European audit bodies | IM/RU | IM/RU | IM/RU | 2 |



| | | | | | | |
|---------|------------------------------|--|-----|-------|-------|---|
| 4.2.1.2 | WagonOrderToORU | Customer sends to Lead RU all information which is needed to carry on the whole transportation from origin to delivery. The Lead RU gives the Origin RU/Service Provider the relevant information which is needed to start the transportation until the interchange to the next RU/Service Provider. | LRU | RU | RU | 3 |
| 4.2.1.2 | WagonOrderToDRU | Customer sends to Lead RU all information which is needed to carry on the whole transportation from origin to delivery. The Lead RU gives the Delivery RU/Service Provider the relevant information which is needed to carry on the transportation during his responsibility until the handover to consignee. | LRU | RU | RU | 3 |
| 4.2.1.2 | WagonOrderToTRU | Customer sends to lead RU all information which is needed to carry on the whole transportation from origin to delivery. The LRU (Service Integrator) gives the Transit RU/Service Provider the relevant information which is needed to carry on the transportation during his responsibility until the interchange to the next RU/Service Provider. | LRU | RU | RU | 3 |
| 4.2.2.2 | PathRequest | This message serves to request a train path. The message is sent from the RU to each IM involved. | RU | IM | IM/RU | 3 |
| 4.2.3.2 | TrainComposition | This message is sent from an RU to an IM defining the composition of the proposed train | RU | IM | IM/RU | 3 |
| 4.2.2.3 | PathDetails | This message is used by the IM to the RU confirming details of the path in response to RU request. | IM | RU | IM/RU | 3 |
| 4.2.2.4 | PathConfirmed | This message is used by the RU to confirm the proposed path of the IM (message "PathDetails") in response to RUs original request. | RU | IM | IM/RU | 3 |
| 4.2.3.3 | TrainAccepted (Optional) | This message is sent from the IM back to the RU indicating, that the train composition is acceptable for the booked path. This message is optional unless agreed to IM/RU. | IM | RU | IM/RU | 3 |
| 4.2.4.2 | TrainRunningForecast | This message is issued from the IM to the neighbouring IM upon departure from or movement past agreed points or prior to reaching the first reporting point if, owing to a delay, the train has not reached the bilaterally agreed initial running time. This message is also issued from the IM to the RU when, at the next stopping or handling station, out-of-schedule running is anticipated that exceeds the threshold agreed with the RU responsible for the train. This message is also issued in any cases for handover points, interchange points, for the destination point and for each other reporting point predefined by contract | IM | IM/RU | IM/RU | 3 |
| 4.2.5.2 | TrainRunning Interruption | This message is issued from the IM to the neighbouring IM and to the path contracted RU, if the train is cancelled due to a train related service disruption. | IM | IM/RU | IM/RU | 3 |
| 4.2.2.5 | PathDetailsRefused | This message is used by the RU to inform the IM, that the Path Details (with changed values to the request or to earlier booked path) are not acceptable. | RU | IM | IM/RU | 3 |
| 4.2.3.4 | TrainNnotSuitable (Optional) | This message is sent from the IM back to the RU indicating, that the train composition provided is not suitable for the previously agreed path. This message is optional unless agreed to IM/RU. | IM | RU | IM/RU | 3 |



| | | | | | | |
|---------|----------------------------------|--|-------|-------|-------|---|
| 4.2.2.6 | PathCancelled | This message is used as a request to cancel a previous booked train path. The message is sent from the RU to the IM, where the train path was requested. | RU | IM | IM/RU | 3 |
| 4.2.3.5 | TrainReady | This message is sent from an RU to IM indicating that the train is ready for access to the network. | RU | IM | IM/RU | 3 |
| 4.2.6.2 | EnquiryTrainRunning Information | This message serves to enquire on the current status of a specified train. | RU | IM | IM/RU | 3 |
| 4.2.6.2 | ResponseTrain RunningInformation | This message is issued following receipt of an enquiry about the train running. It delivers all information for the specified train about the current status of the train. | IM | RU | IM/RU | 3 |
| 4.2.2.7 | PathNotAvailable | This message is sent from an IM to an RU indicating, that the booked path is not available (path cancelled by IM). | IM | RU | IM/RU | 3 |
| 4.2.3.6 | TrainPosition (Optional) | This message is sent from IM to RU defining exactly when and where the train should present itself upon the network. This message is optional unless agreed to IM/RU. | IM | RU | IM/RU | 3 |
| 4.2.6.3 | EnquiryTrainDelay Performance | Permits the RU to enquire about all delays of a specific train from a particular IM | RU | IM | IM/RU | 3 |
| 4.2.6.3 | ResponseTrainDelay Performance | This message is issued following receipt of an enquiry about the train delay / performance. It delivers a report of all the delays to a specified train at all reporting points with a particular IM. | IM | RU | IM/RU | 3 |
| 4.2.7.3 | WagonETA/ETI Message | This message is sent by the RU to the next RU in the transport chain to give him the calculation of its ETI. The last RU sends this message with ETA to the Lead RU, which may inform its customer. Following the handover information from the IM, the RU sends with this message also the updated ETI to the next RU and the last RU sends the updated ETA to the LRU. | RU | RU | RU | 3 |
| 4.2.2.8 | ReceiptConfirmation | This message is sent from the recipient of a message to the original sender of the message, when the required response cannot be made available in "real-time". | IM/RU | IM/RU | IM/RU | 3 |
| 4.2.3.7 | TrainAtStart (Optional) | This message is sent from the RU (train responsibility) to IM (control responsibility) to indicate, that the train has started its journey. This message is optional unless agreed to IM/RU. | RU | IM | IM/RU | 3 |
| 4.2.6.4 | EnquiryTrainIdentifier | This message serves to enquire upon the current specified train ID and its previous train ID's. Any of the train ID's can be used for the enquiry. | RU | IM | IM/RU | 3 |
| 4.2.6.4 | ResponseTrain Identifiers | This message is issued following receipt of an enquiry about train identifiers. It gives a report of the current and all previous train ID's of a specified train. | IM | RU | IM/RU | 3 |
| 4.2.7.4 | AlertMessage | Following the comparison between the actual ETA and the commitment to the customer, the Lead RU sends this Alert Message to the actual RU in charge and to all following RUs, involved in the transport chain. | RU | RU | RU | 3 |
| 4.2.6.5 | EnquiryTrainRunning Forecast | This message serves to enquire on the forecast time for a specified train at a particular reporting location or by missing out the reporting location to enquire on the forecast time at the handover point from the IM. | RU | IM | IM/RU | 3 |

Deliverable 3 – Public

PROJECT No: 2005-EU-93008-S



| | | | | | | |
|----------|--|---|-------|-------|-------|---|
| 4.2.6.5 | ResponseTrain Running Forecast | This message is issued following receipt of an enquiry about train forecast. It gives the forecasted time of a specified train at a specified location. If the location is not specified the forecast time at the handover point will be sent. | IM | RU | IM/RU | 3 |
| 4.2.6.6 | EnquiryTrainsAt ReportingLocations | This message serves to enquire on all trains of an RU at a particular reporting location or by missing out the reporting location to enquire on the trains at the handover point from the IM. | RU | IM | IM/RU | 3 |
| 4.2.6.6 | ResponseTrainsAt Reporting Location | This message is issued following receipt of an enquiry about trains at a particular reporting location. It gives a report of the forecasted time for all trains of the enquirer at a specified location. If the location was not specified by the enquirer, the forecast time at the handover points for the different trains will be sent. | IM | RU | IM/RU | 3 |
| 4.2.7.5 | EnquiryWagon Deviation | This message serves to enquire on the current status of a specified wagon. | LRU | RU | RU | 3 |
| 4.2.7.5 | ResponseWagon Deviation | This message is issued following receipt of an enquiry about the wagon deviation. It delivers a report of all deviations of a specified wagon at all reporting points. | RU | LRU | RU | 3 |
| 4.2.12.1 | Existing Train Control Systems | Centrally stored reference file of command and control systems used | IM/RU | IM/RU | IM/RU | 3 |
| 4.2.12.1 | Locomotive Types | Centrally stored reference file of coded Locomotive types | RU | IM/RU | IM/RU | 3 |
| 4.2.12.2 | Trip plan for wagon / Intermodal unit | The Wagon Trip Plans must be stored by each LRU in a database. These databases must be accessible via the Common Interface Predetermined Trip Plans | RU | RU | RU | 3 |
| 4.2.12.2 | Wagon Trip Plan Databases | Wagon Trip Plans must be stored by each LRU in a database. These databases must be accessible via the Common Interace. | RU | RU | RU | 3 |



Appendix B - Overview for Optional TAF TSI Components

| TSI Ref | | Comments | sender | receiver | Impact | SEDP Phasing |
|----------|--|---|--------|----------|--------|--------------|
| N° | Name | | | | | |
| 4.2.1.1 | Consignment Note Handling and conversion into Wagon Orders | The consignment note data must be extracted and/or supplemented by the Lead RU and sent to the contracted RU partners as well as the WIMO in line with the TAF-TSI requirements | RU | RU | RU | 1 |
| 4.2.1 | Wagon order data to populate the WIMO for Dangerous Goods | Selected data of the consignment note data must also be accessible for all partners (e.g. IM, Keeper...) in the transport chain including customers, These are especially per wagon: - Dangerous goods information, - Transportation unit. | RU | RU | RU | 1 |
| 4.2.1 | Wagon order data to populate the WIMO for Load/Weight | Selected data of the consignment note data must also be accessible for all partners (e.g. IM, Keeper...) in the transport chain including customers, These are especially per wagon: - Load weight (Gross weight of the load), - Transportation unit. | RU | RU | RU | 1 |
| 4.2.2.3 | Path Cancelled by IM | This process is realised by the implementation of a new Path Details message | IM | RU | RU/IM | 3 |
| 4.2.7.2 | ETI/ETA calculation | The TSI description bases the calculation on dynamic trip planning. As this functionality is difficult to realise as business and IT processes need to be in place, it is recommended to implement this in phases (represented by various quality levels) Quality level 1 = Historical Quality level 2 = Predetermined Quality level 3 = Dynamic Trip Planning | RU | RU | RU | 2 |
| 4.2.7.2 | ETI/ETA calculation from predetermined Trip Plans | The TSI description bases the calculation on dynamic trip planning. As this functionality is difficult to realise as business and IT processes need to be in place, it is recommended to implement this in phases (represented by various quality levels) Quality level 1 = Historical Quality level 2 = Predetermined Quality level 3 = Dynamic Trip Planning | RU | RU | RU | 3 |
| 4.2.7.2 | ETI/ETA calculation (dynamic trip plans) | The TSI description bases the calculation on dynamic trip planning. As this functionality is difficult to realise as business and IT processes need to be in place, it is recommended to implement this in phases (represented by various quality levels) Quality level 1 = Historical Quality level 2 = Predetermined Quality level 3 = Dynamic Trip Planning | RU | RU | RU | 4 |
| 4.2.10.1 | Data Quality Measurement - Customer Related | In contracts between RUs acting as service integrators (LRU) and customers, commitments can be made (depending on the individual agreement) regarding transit time, ETA and alert resolution. The most relevant | RU | RU | RU | 2 |



| TSI Ref | | Comments | sender | receiver | Impact | SEDP Phasing |
|----------|---|---|--------|----------|--------|--------------|
| N° | Name | | | | | |
| | | messages for this measurement of quality are: <ul style="list-style-type: none"> • Release Notice, • Departure Notice, • Delivery notice. | | | | |
| 4.2.10.1 | Data Quality Measurement – Service Provider Related | In contracts between a Lead RU and other transport service providers commitments can be made concerning transit times (hours) with individual service providers as follows: <ul style="list-style-type: none"> • Release cut off / Pull time to interchange delivery, • Pick up to in gate, • In gate to loading, • Interchange receipt to interchange delivery, • Interchange receipt to placement / constructive placement, • Grounding to delivery. The most relevant messages for this measurement of quality are: <ul style="list-style-type: none"> • Release Notice, • Departure Notice, • Yard Arrival, • Yard Departure, • Arrival Notice, • Wagon Interchange Delivery, • Wagon Interchange Receipt, • Wagon Interchange Refused. | RU | RU | RU | 2 |
| 4.2.11.2 | Populate the IM Restriction Databases | Population of the databases for IM Restrictions. | IM | IM | IM | 1 |
| 4.2.13 | Electronic transmission of documents | The description in chapter 4.2.14 (presents the communication network to be used for data exchange. This network and the described security handling allow any type of network transmission, such as email, file transfer (ftp, http), etc. The type to choose can then be decided upon by the parties involved in the information exchange, which means, that the electronic transmission of documents, for example, via ftp is given. | | | RU/IM | 1 |
| 4.2.10.3 | Quality improvement measurement tools – Train Performance | In contracts between RUs and IMs, a punctuality level for train schedules at specified reporting points can be specified as can the accuracy of train ETAs and ETHs. The most relevant messages for this measurement of quality are: <ul style="list-style-type: none"> - Train Running Forecast, - Train Running Information, - Enquiry / Response about train delay / performance. | | | IM | 3 |
| 4.2.12.2 | Extension of the WIMO to Intermodal Units | The movement part for a wagon or Intermodal unit in the databases is set up at the latest when receiving the release time for the wagons or Intermodal unit from the customer. | | | RU | 1 |
| 4.2.11.3 | Populate the Rolling Stock databases | Populate the databases called for in mandatory component 4.2.11.3 | | | RU | 3 |
| 4.2.12.2 | Read from IM Restriction Database | Ability to access and read the IM Restriction Database | | | RU | 3 |
| 4.2.10.4 | Quality improvement measurement tools – Path availability planned | In contracts between RUs and IMs path availability to run trains will be clearly described in terms of a range of times at specified points. Train specifications in terms of maximum length and gross weight, loading gauge etc., will also be | | | IM | 3 |



| TSI Ref | | Comments | sender | receiver | Impact | SEDP Phasing |
|----------|---|--|--------|----------|--------|--------------|
| N° | Name | | | | | |
| | | <p>covered in these contracts. This aspect will be addressed under item number 6 (IM / RU: Train composition quality). The procedures and time frames for confirming the utilisation of a path, cancelling the use of a planned path and the extent to which a path can be used outside (early or late) the specified range of times will also be covered in these contracts. The most relevant messages for this measurement of quality are:</p> <ul style="list-style-type: none"> • Path Cancelled, • Path Not Available. | | | | |
| 4.2.12.2 | Infrastructure Databases Train | <p>In addition to the mandatory databases mentioned above, at each IM side a train database may be installed. This infrastructure manager train database corresponds to the movement part of the Wagon and Intermodal Unit Operational Database. The main data entry are the train related data of the train composition message from the RU. All train events result in an update of this train related database. An alternative storage possibility for these data is the path database (chapter 4.2.2: Path Request). These databases must be accessible via the Common Interface (4.2.14.1: General Architecture and 4.2.14.7: Common Interface)</p> | | | IM | 3 |
| 4.2.10.5 | Quality improvement measurement tools – Path availability on short notice | <p>When an RU wants to run a train outside the time limits established for a planned path; a path request on short notice must be sent to the IM(s) involved (as provided in the Directive 2001/14/EC). Periodically the RU will compare the path request and the response data for producing reports as follows:</p> <ul style="list-style-type: none"> - Path request response time against framework agreement, - Number of paths supplied within certain time periods, within the requested time, - Number of rejected path requests. | | | RU/IM | 3 |
| 4.2.14.2 | Definition of the network | <p>Networking in this case means the method and philosophy of communication and does not mean the physical network. Rail interoperability is based on a common Information Exchange Architecture, known and adopted by all participants, thus encouraging and lowering barriers for new entrants, especially customers. The security issue will therefore be addressed not by the network (VPN, tunnelling, ...), but by exchanging and managing inherently secure messages.</p> | | | RU/IM | 1 |
| 4.2.10.6 | Quality improvement measurement tools – Train Composition | <p>When the train ready messages and / or train composition lists are sent by an RU to the IM(s) or to other RUs; they must comply with the train specifications contained within the applicable contract. For the checking of this compliance and therefore for the measurement of the train composition quality the most relevant messages are:</p> <ul style="list-style-type: none"> • Train Composition, • Train Not Suitable. | | | RU/IM | 3 |



| TSI Ref | | Comments | sender | receiver | Impact | SEDP Phasing |
|----------|---|--|--------|----------|--------|--------------|
| N° | Name | | | | | |
| 4.2.14.4 | Specification for Security Requirements | To achieve a high level of security, all messages must be self contained, which means that the information in the message is secured and the receiver can verify the authenticity of the message. This may be solved by using an encryption and signing scheme similar to email encryption. This makes it possible to use any type of network transmission, like email, file transfer (ftp, http), etc. The actual type to choose can then be decided upon by the parties involved in the information exchange | | | RU/IM | 1 |
| 4.2.14.5 | Specification for Encryption Requirements | Either asymmetric encryption or a hybrid solution based on symmetric encryption with public key protection must be used, due to the fact that sharing a common secret key among many actors will fail at some point. A higher level of security is easier to achieve if every actor takes responsibility for its own pair of keys, even though a high level of integrity of the central repository (the key server) is required | | | RU/IM | 1 |